

# *arteferro*

**SYSTEM**

Arteferro is a brand of



# THE GROUP

/ IL GRUPPO



**GONZATO**  
GROUP

**GONZATO GROUP ITALIA**

WORLDWIDE

**Gonzato Group** Texas / **Gonzato Group** Florida /  
**Gonzato Group** Brasil / **Gonzato Group** Mexico / **Gonzato Group** Russia /  
**Gonzato Group** Argentina / **Gonzato Group** Chile /  
**Gonzato Group** China

EUROPEAN

**Gonzato Group** Italia / **Gonzato Group** France /  
**Gonzato Group** España / **Gonzato Group** Croatia /  
**Gonzato Group** Romania

**WM**  
DESIGN

**arterferro**

**A Brand of Gonzato Group**



## **WE DEVELOP DESIGN CULTURE**

The revolutionary design of these products, founded on careful typological research, makes them among the most modern and successful interpretations of the ancient and noble art of wrought iron.

The materials used are ecologically sustainable and they represent the raw materials of the collection. Arteferro's aim is to continue to develop its own design culture and production technology in order to be able to offer functionally innovative ideas which are exclusive from an aesthetic point of view and can ensure maximum reliability and safety over the time.

## **CREIAMO CULTURA DI PRODOTTO**

L'attenta ricerca tipologica che sta alla base di questi prodotti dal design rivoluzionario li qualifica tra le più moderne e riuscite interpretazioni dell'antica e nobile arte del ferro battuto.

I materiali utilizzati sono ecologicamente sostenibili e rappresentano le materie prime della collezione. L'obiettivo di Arteferro è quello di continuare a sviluppare la propria cultura progettuale e tecnologia produttiva, per offrire proposte funzionalmente innovative, esteticamente esclusive e in grado di assicurare la massima affidabilità e sicurezza nel tempo.

***arteferro***

# CONTENTS

# CONTENUTI

6	<b>WHY ARTEFERRO? / PERCHÈ ARTEFERRO?</b>
	<b>FOCUS ON SAFETY / FOCUS SICUREZZA</b>
8	REGULATIONS / NORMATIVE
9	THE LAB / IL LABORATORIO
	<b>WHAT IS ARTEFERRO SYSTEM? / COS'E' ARTEFERRO SYSTEM?</b>
10	THE L'IDEA / L'IDEA
	<b>THE ARTEFERRO CERTIFIED SYSTEM / IL SISTEMA CERTIFICATO ARTEFERRO</b>
11	THE SYSTEM / IL SISTEMA
12	ARTEFERRO RAILING SYSTEM - ARTEFERRO FRENCH BALCONY
13	FINISHING / LE FINITURE
14	THE STRUCTURE AND NEWEL POSTS / LA STRUTTURA E I MONTANTI
	<b>THE PANELS / I PANNELLI</b>
16	MOD. SIRMIONE
18	MOD. FIRENZE
20	MOD. TRIESTE
22	MOD. ROMA
24	MOD. BOLZANO
26	MOD. ORTIGGIA
27	MOD. PORTOFINO
28	MOD. BOLOGNA
30	MOD. STRESA
31	MOD. NAPOLI
32	MOD. VENEZIA
34	MOD. PERUGIA
36	MOD. ASCOLI
38	MOD. TRANI
40	MOD. CAGLIARI
42	MOD. AOSTA
44	MOD. JESOLO
46	MOD. ISEO
48	MOD. TORINO
50	MOD. VICENZA
52	MOD. CORTINA
54	MOD. MILANO
56	
58	<b>ACCESSORIES / ACCESSORI</b>
59	<b>GUARANTEES / GARANZIE</b>

# WHY ARTEFERRO PERCHE' ARTEFERRO

## PRODUCTION

FROM CONCEPT TO PRODUCTION, WE TAKE CARE OF EVERY ASPECT OF THE PRODUCT. Our items, unlike most other products on the market, are manufactured in our production centres in Italy and Europe and subjected to quality testing; we know the entire life cycle of each piece, from creation to delivery. Furthermore, we are the only company in the industry that can boast a production capacity able to meet any special request with such short production timelines.

## PRODUZIONE

DALL'IDEAZIONE ALLA PRODUZIONE CI OCCUPIAMO DI OGNI ASPETTO DEL PRODOTTO. I nostri articoli, rispetto alla gran parte dei prodotti che si trovano sul mercato, sono realizzati nei nostri centri produttivi in Italia ed Europa, sottostando a test qualitativi che ci consentono di conoscere la vita di ogni pezzo, dalla sua nascita alla sua consegna. Inoltre, siamo l'unica azienda del settore che può vantare una capacità produttiva in grado di soddisfare ogni richiesta speciale entro tempi di stretta produzione.

## GUARANTEED, CERTIFIED AND PATENTED QUALITY

OUR ARTICLES ARE MADE IN OUR PRODUCTIVE CENTRES IN ITALY AND EUROPE. We can manage the entire production line guaranteeing in this way the best final quality. That quality is known for years by certifications ISO 9001 and ISO 14011. Another added value, confirming our originality and quality, is certified by many of our patented articles, in order to protect both the talent of our designers and the trust of our clients. The traceability of our products is guaranteed through an appropriate labels affixed to our articles that identify their origin against counterfeiting.

## QUALITÀ GARANTITA, CERTIFICATA E BREVETTATA

I NOSTRI ARTICOLI VENGONO REALIZZATI NEI NOSTRI CENTRI PRODUTTIVI IN ITALIA E IN EUROPA. Possiamo quindi gestire tutta la catena di produzione garantendo così la migliore qualità finale. Tale qualità è da anni riconosciuta anche dalle certificazioni ottenute ISO 9001 e ISO 14011. Un ulteriore valore aggiunto, sempre a garanzia di originalità e qualità, è rappresentato dai brevetti registrati per molti dei nostri articoli, con lo scopo di tutelare sia l'ingegno dei nostri designer sia la fiducia dei nostri clienti. La tracciabilità dei nostri prodotti è garantita tramite apposite etichette apposte ai nostri articoli che ne identificano l'origine contro la contraffazione.





# WHY ARTEFERRO PERCHE' ARTEFERRO

## INNOVATION

THE CUSTOMER AND THEIR NEEDS ARE THE PRIMARY FOCUS OF OUR ATTENTION. For this reason, a team of designers and engineers work daily designing new products, combining our aesthetic standards with current technical requirements. We are constantly looking at different materials to use in our lines to enhance their structural and aesthetic characteristics (wood, glass and many more). We believe that our products should be easy to assemble and integrate with other architectural elements, in order to adapt to the environment in which they are installed with maximum flexibility.

## INNOVAZIONE

IL CLIENTE E LE SUE ESIGENZE SONO IL FULCRO DELLA NOSTRA ATTENZIONE. Per questo motivo un team di designers ed ingegneri lavora quotidianamente all'ideazione di nuovi prodotti che soddisfino sempre più la necessità di bellezza in armonia con le esigenze tecniche oggi esistenti. Siamo costantemente alla ricerca di materiali diversi da accompagnare alle nostre linee per esaltarne le caratteristiche strutturali ed estetiche (legno, vetro e molti altri ancora). Crediamo che i prodotti debbano essere semplici da assemblare e da integrare con gli altri elementi architettonici in modo da potersi adattare all'ambiente in cui vengono installati con la massima flessibilità.



## CUSTOMISATION AND TOP QUALITY

WITH OUR WIDE CHOICE OF FINISHES AND MATERIALS. From design to production, every step of the process is carried out by our designers and technicians, to satisfy every structural, architectural and aesthetic requirement. Send us a plan of your terrace or fence and we'll take care of everything else.

## PERSONALIZZAZIONE AL MASSIMO DELLA QUALITA'

AMPIA SCELTA DI FINITURE E MATERIALI. Dal progetto, alla realizzazione, ogni passaggio è svolto dai nostri progettisti e tecnici che sapranno soddisfare ogni esigenza strutturale, architettonica ed estetica. Inviaci la pianta del tuo terrazzo o della tua cancellata e penseremo noi a tutto.

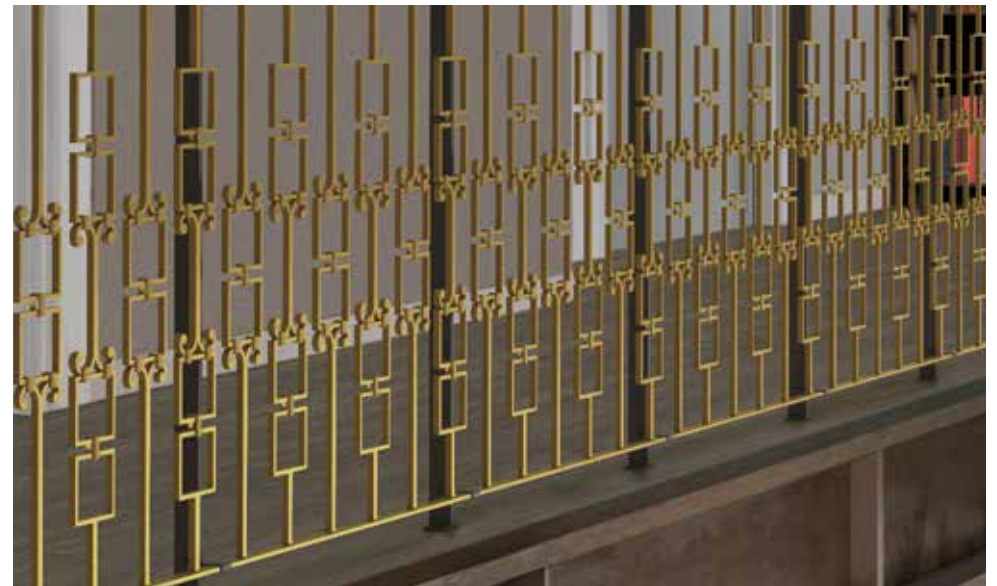



# REGULATIONS LE NORMATIVE

THE RAILINGS MUST  
BE H 1000 MM.

I PARAPETTI  
DEVONO ESSERE H 1000 MM.



RAILINGS, BALUSTRADES OR FENCES MUST BE  
NON-TRAVERSABLE BY A 100 MM DIAMETRE SPHERE  
AT ANY POINT.

RINGHIERE, BALAUSTRÉ O PARAPETTI DEVONO ESSERE  
INATTRAVERSABILI IN QUALSIASI PUNTO DA UNA SFERA  
DI 100 MM DI DIAMETRO.



OVER 500 MM OF FALLING, IT IS COMPULSORY NOT  
TO HAVE CLIMBABLE ELEMENTS.

AL DI SOPRA DI 500 MM DI CADUTA,  
È OBBLIGATORIO NON AVERE ELEMENTI SCALABILI.

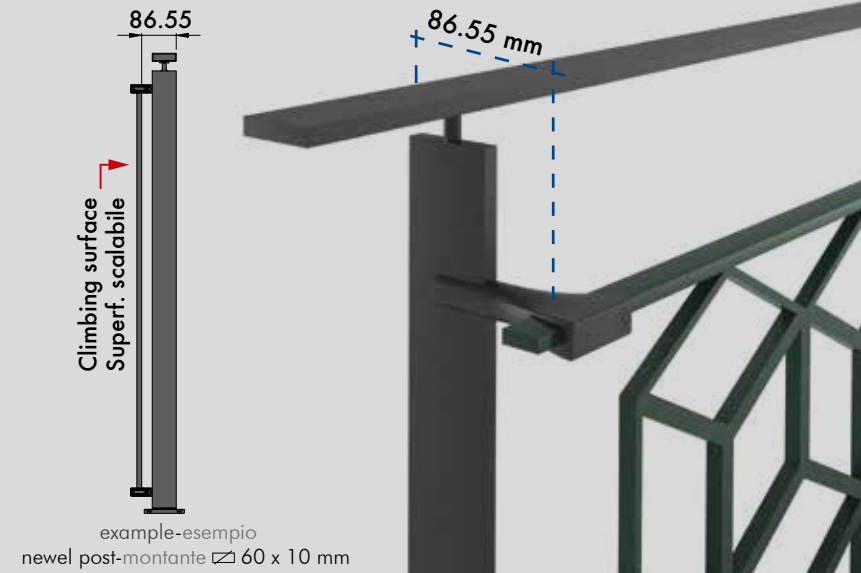
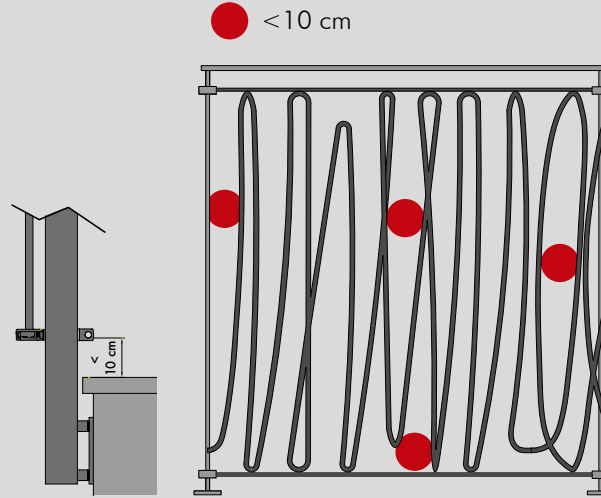
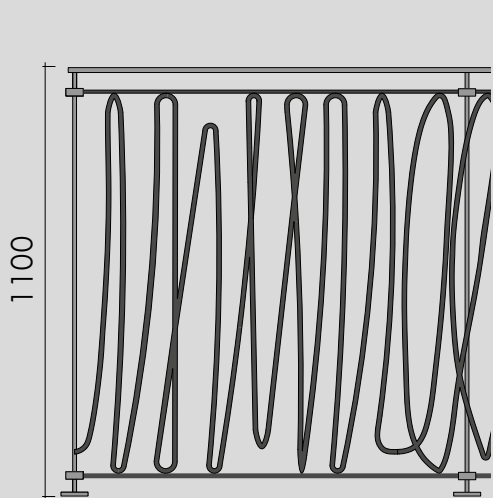

The **Arteferro System** railings  
are **1100 mm** high and meet the standards  
UNI 10809:1999.

I nostri parapetti **Arteferro System**  
sono alti **1100 mm** e rispondono alle normative  
UNI 10809:1999.



The protection elements of our **Arteferro System**  
railings have a distance from each other  
less than **10 cm**.

Gli elementi di protezione dei nostri parapetti  
**Arteferro System** hanno un'apertura  
inferiore tra di loro di **10 cm**.



The handrail of the **Arteferro System** is positioned out of axis from  
the infill panel, so it meets the safety requirements regarding the  
railings anti-climbing.

Il corrimano installato nel **Arteferro System** si trova sempre  
disassato rispetto al pannello di tamponamento, risponde quindi ai  
requisiti di sicurezza in merito alla scalabilità dei parapetti.

Values achievable with standard element  
Valori raggiungibili con elementi standard

Values achievable with customized elements  
Valori raggiungibili con elementi su misura

	Car.	End use Destinazione d'uso	Example Esempio	EUROPEAN REGULATION NORMA EUROPEA (EUROCODE 1) OSK (KN/M) EN 1991	ITALIAN REGULATION NORMA ITALIANA OSK (KN/M) NTC 2018	Project value Valore di progetto (R/N/m)	Project calculation break value Valore rottura di calcolo di progetto (k x s) 1,5
DOMESTIC	A	Areas for domestic and residential activities Aree per attività domestiche e residenziali	Rooms in residential buildings and detached houses; rooms and aisles in hospitals, hotel rooms and hotel kitchens and bathrooms. Camere in edifici residenziali e abitazioni unifamiliari; camere e corsie negli ospedali camere negli alberghi e cucine e bagni negli ostelli	0,5	1	1	1,5
	B	Office areas Aree per uffici					
COMMERCIAL	C	Areas where people can meet (with the exception of A, B and D1 areas) Aree nelle quali le persone possono adunarsi (ad eccezione delle aree definite nelle categorie A, B e D1)	C1: Areas with tables, etc, such as in schools, cafés, restaurants, halls and libraries. C1: Aree con tavoli, ecc, per esempio, aree in scuole, caffè, ristoranti, sale per banchetti, sale di lettura, sale di ricevimento	0,5	1	1	1,5
			C2: Seating areas, such as in churches, theaters, cinemas, lecture halls and railway station lounges. C2: Aree con posti a sedere fissi, per esempio, aree nelle chiese, teatri o cinema, sale per conferenze, aule universitarie, aule magne, sale d'attesa ferroviarie	1	2	2	3
			C3: Areas without barriers to people movement, such as museums, exhibitions, admission areas in public places and administrative centers, hotels, hospitals and railway stations entrance halls. C3: Aree prive di ostacoli al movimento delle persone, per esempio, aree nei musei, sale d'esposizione, ecc. e aree di accesso negli edifici pubblici ed amministrativi, alberghi, ospedali, atrii di stazioni ferroviarie	1	3	3	4,5
			C4: Areas liable to physical activities, such as dance halls, gyms and stages. C4: Aree con possibile svolgimento di attività fisiche, per esempio, sale da ballo, palestre, palcoscenici.	1	3	3	4,5
			C5: Crowded areas, for example buildings that host public events, such as concert halls, indoor stadium including grandstands, bleachers and access areas and railway platforms. C5: Aree suscettibili di grande affollamento, per esempio in edifici che ospitano eventi pubblici, come sale da concerto, palazzi degli sport, incluse le tribune, le gradinate e le aree d'accesso e le piattaforme ferroviarie.	3	3	3	4,5
			D	Business areas Aree per attività commerciali	D1: Areas in retail stores D2: Areas in shopping centers D1: Aree per acquisti generici al dettaglio D2: Aree in grandi magazzini	3	2
EXTRA	E	Warehouses Magazzini	E1: Areas liable to merchandise accumulation, admission and storing areas included. E2: Manufacturing use E1: Aree suscettibili all'accumulo di merci, incluse le aree d'accesso Aree per immagazzinamento inclusi immagazzinamento di libri e altri documenti. E2: Uso industriale	2	1	1	1,5

# THE LAB IL LABORATORIO



In its factory, Arterferro created a tests area, where all output is thoroughly tested. You can see below some of the tests we regularly perform. Our products have always been manufactured in order to reach the highest standards in quality and safety because we want to be sure that our systems are up to their function. To verify compliance with the specific functional and performance requirements, we carry in our test area a set of tests, measurements, investigations and inspections.

Our products are qualitatively tested before, during and after production by qualified experts. Even more so, for 15 years we relied upon several certification authorities to certify our products, submitting them to several tests apt to determine in an objective way their performance. The design and production quality of Arterferro item allowed us to obtain certifications according to the standards currently in force in many European countries and to ensure the choice of our customers.

Follow some test that we make every day.

## 1 STATIC TESTS PRE- AND POST-BREAKAGE

These tests are performed according to strict safety standards, defining the criteria and static, concentrated and distributed loads, pre- and post-breakage, of railings, balustrades and prefabricated railings.

## 2 DYNAMIC TESTS

These tests are performed by striking specific points of the railing systems with a moving object. The ultimate purpose is to ascertain the level of safety, even in case of sudden impacts.

Arterferro ha realizzato nei propri stabilimenti un'area appositamente dedicata ai test dei vari sistemi al fine collaudare rigorosamente tutta la produzione. Pertanto i nostri prodotti sono da sempre progettati e realizzati per offrire il massimo livello qualitativo e di sicurezza perché vogliamo essere certi che siano all'altezza della funzione che andranno a svolgere. Per verificare la rispondenza agli specifici requisiti funzionali e prestazionali, effettuiamo nella nostra Test Area un insieme di prove, misurazioni, accertamenti ed ispezioni. I nostri prodotti sono anche testati qualitativamente prima, durante e dopo la produzione da personale esperto e specializzato. Da ormai 15 anni ci affidiamo a più enti di certificazione che sottopongono i nostri prodotti a diverse prove atte a determinare, in modo oggettivo, le loro prestazioni. La qualità progettuale e produttiva degli elementi Arterferro ci ha permesso di ottenere certificazioni secondo le normative attualmente vigenti in molti paesi europei e di garantire così la scelta della nostra clientela. Di seguito, alcune delle prove che si effettuano regolarmente.

## 1 PROVE STATICHE PRE E POST ROTTURA

Questi test vengono eseguiti secondo rigidi standard di sicurezza, i quali definiscono i criteri ed i carichi statici, concentrati e distribuiti, pre e post rottura, di ringhiere, balaustre e parapetti prefabbricati.

## 2 PROVE DINAMICHE

Questi test vengono eseguiti facendo impattare un corpo in movimento in un punto specifico del sistema parapetto. Il fine ultimo è quello di accertare il livello di sicurezza anche in caso di impatti improvvisi.



# THE IDEA L'IDEA

SAFETY, DESIGN, EASE AND SPEED OF INSTALLATION: THIS IS THE CERTIFIED ARTEFERRO

SICUREZZA, DESIGN, FACILITÀ E VELOCITÀ DI INSTALLAZIONE: QUESTO È IL SISTEMA CERTIFICATO ARTEFERRO

## SAFETY - SICUREZZA



## DESIGN



## EASY INSTALLATION FACILITÀ DI INSTALLAZIONE



In the beginning we wondered if it was possible to combine beauty and safety in a product such as wrought iron and we found the answer in the idea of designing and subsequent architectural production of the CERTIFIED ARTEFERRO SYSTEM. Safety has in fact become, over the years, for us and for our customers, synonymous with professionalism and competence.

Driven by these motivations, the Arteferro team, following the logic of "thinking first, designing second", has first thought and then created a system of certified and modular parapets, tested in our laboratories with a project load of 2kN/m with safety load up to 3,5kN/m. In a world that goes fast, where the time is the heart of everything, the other features that our system must have, should be the ease and the speed of installation. From that, the idea of the already prefabricated module, able to create a pleasant aesthetic effect without requiring waste of time in the installation. Thanks to this feature, the professional can work with a ready-to-use module that does not require further welding, painting or galvanizing. In fact, our panels are totally customizable in terms of materials, colors and finishes.

The CERTIFIED ARTEFERRO is the answer to this idea and this catalog is what follows.

We immediately realize the freshness of the lines wisely installed in environments of great aesthetic taste.

In principio ci siamo chiesti se fosse possibile coniugare bellezza e sicurezza in un prodotto come il ferro battuto e la risposta l'abbiamo trovata nell'idea della progettazione e successiva produzione architettonica di ARTEFERRO SYSTEM CERTIFICATO. La sicurezza è diventata infatti negli anni, per noi e per i clienti, sinonimo di professionalità e competenza.

Spinti da queste motivazioni, il team Arteferro, secondo la logica del "thinking first, designing second", ha prima pensato e poi creato un sistema di parapetti certificati e modulari, testati all'interno dei nostri laboratori verificati con carichi di progetto di 2kN/m e spinti fino a 3,5 kN/m di rottura. In un mondo che va veloce, dove il tempo fa da cardine a tutto, le altre caratteristiche che doveva possedere il nostro sistema dovevano essere pertanto la facilità e la velocità d'installazione. Da lì l'idea del modulo già prefabbricato, capace di creare un piacevole effetto estetico senza richiedere sprechi di tempo nell'installazione. Grazie a questa caratteristica, il professionista si trova di fronte ad un modulo pronto all'uso che non richiede ulteriori saldature, verniciature e zincature. I nostri pannelli, infatti, sono totalmente personalizzabili per quanto riguarda i materiali, i colori e le finiture.

IL SISTEMA CERTIFICATO ARTEFERRO è la risposta a questa idea e questo catalogo è ciò che ne consegue.

Ci rendiamo conto fin da subito della freschezza delle linee, sapientemente installate in ambienti di grande gusto estetico



TUTORIAL VIDEOS

# THE SYSTEM IL SISTEMA

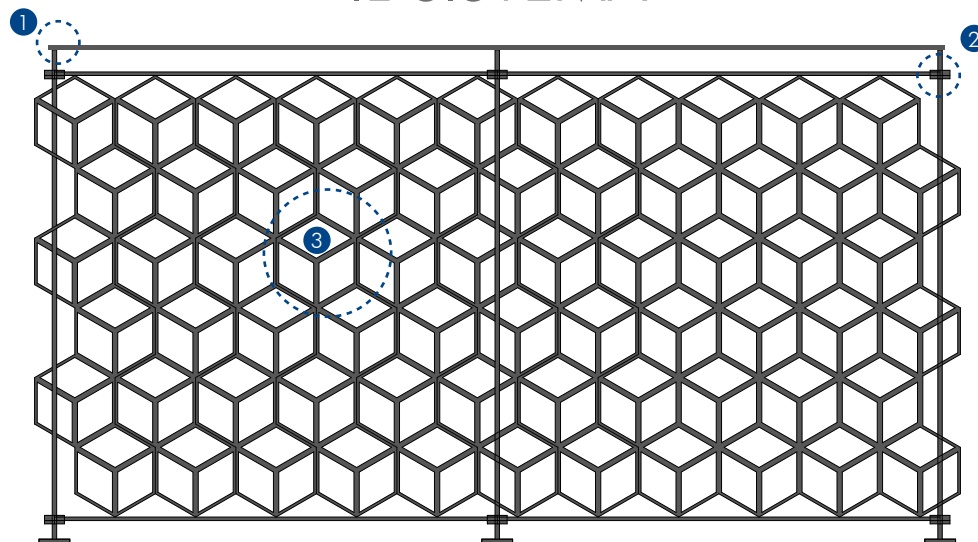

TO REACH THE CERTIFICATION STANDARDS  
IS ALWAYS MANDATORY  
THE USE OF THREADED INSERTS

PER RAGGIUNGERE GLI STANDARD  
DI CERTIFICAZIONE È SEMPRE OBBLIGATORIO  
L'UTILIZZO DEGLI INSERTI FILETTATI

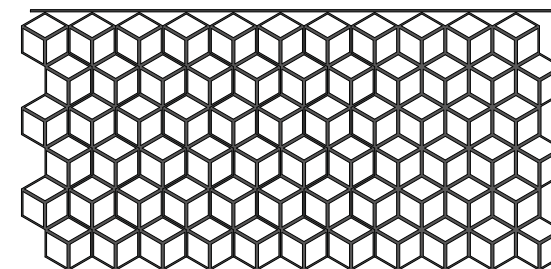

1

The Arteferro post is the supporting structure of our certified system that guarantees its seal. It resists to the following loading stress of 1kN/m, 2kN/m. It is available in a flat, round and in a squared version.

2

The clamp, the element that connects the panel and the supporting structure, has been designed to adapt to different types of post: flat, square, round. The iron, the construction material, is here in a black micaceous version.

3

The panel is the ornamental part of our timeless design system. The geometric lines of the collection are blended with the materials used. The iron revisited in this product gives life to an object that talk between past and future.

Il montante Arteferro è la struttura portante del nostro sistema certificato che ne garantisce la tenuta. Resiste a sollecitazioni di carico di 1 kN/m e 2 kN/m. Disponibile in versione piatta, in versione rotonda e in versione quadrata.

La pinza, elemento di congiunzione tra il pannello di tamponamento e la struttura portante è stata progettata per adattarsi a diversi tipi di montante: piatto, quadrato, tondo. Il ferro, materiale di costruzione, qui è in versione nero micaceo.

Il tamponamento è la parte ornamentale del nostro sistema dal design senza tempo. Le linee geometriche della collezione si fondono sapientemente con i materiali utilizzati. Il ferro rivisitato in questo prodotto dà vita a un oggetto che dialoga tra passato e futuro.

# ARTEFERRO RAILING SYSTEM

Our patented modular railing system totally revolutionizes the concept of iron railing. In fact, starting from the positioning of the newel posts, the operation that will be performed before the positioning of the panels, it will be possible to delimit any surface exposed to the risk of falling from above in a very short time. It is positioned on the market as an alternative and innovative product with a modern and prestigious line, it can be adopted for any type of requirement without any limit and in compliance with current legislation. Perfectly suitable for the branches of private, public construction, fully customizable in the design loads 1 kN and 2kN, thanks to the certified newel posts. The wide range of our panels allows the customer to place and customize the patented modular railing in any environment, choosing the most suitable type of infill, making it totally unique.

**The Arteferro Systems products are totally customizable.  
We can supply panels on ramp for staircase balustrades.**

Il nostro parapetto modulare brevettato rivoluziona totalmente il concetto di parapetto in ferro. Infatti partendo dal posizionamento dei montanti, operazione che deve essere eseguita antecedentemente al posizionamento dei pannelli, sarà possibile delimitare qualsiasi superficie esposta al rischio di caduta dall'alto in tempi brevissimi. Esso si posiziona sul mercato come prodotto alternativo, innovativo con una linea moderna e di pregio, può essere adottato per qualsiasi tipo di esigenza senza alcun limite e conforme alle normative vigenti di legge. Perfettamente idoneo per i rami dell'edilizia privata, pubblica, totalmente personalizzabile nei carichi di spinta 1 kN e 2kN, grazie al montante certificato. L'ampia gamma dei nostri pannelli permette al cliente di collocare e personalizzare il parapetto modulare brevettato in qualsiasi ambiente, scegliendo il tipo di tamponatura più idonea al caso, rendendolo totalmente unico.

**I prodotti ArteferroSystem sono totalmente customizzabili.  
Su misura forniamo pannelli in andamento per parapetti di scale.**

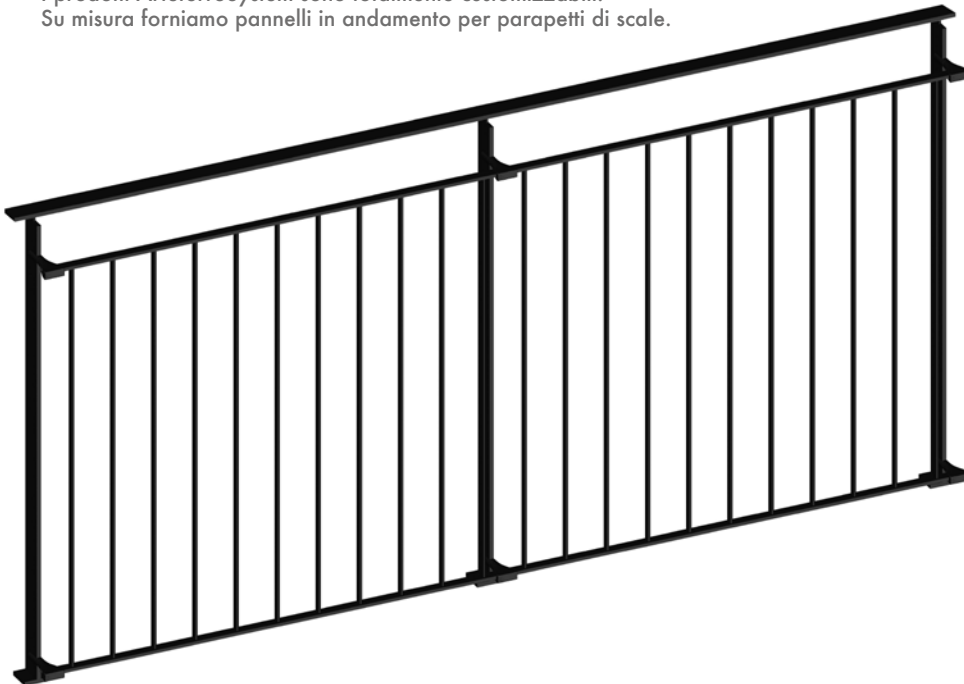

## ARTEFERRO FRENCH BALCONY



Arteferro French Balcony is a modern closure, capable of responding to the needs of each customer. Ideal for who needs to close the rooms that face the outside, it transforms the views into a protected space, not compromising the architecture of the building façade. Available in two versions: wall anchorage and external insulation coat anchorage.

Arteferro French Balcony è una chiusura moderna, capace di rispondere alle esigenze di ogni cliente. Ideale per chi ha necessità di chiudere gli ambienti che affacciano sull'esterno, trasforma gli affacci in uno spazio protetto, non compromettendo l'architettura della facciata dell'edificio. Disponibile nelle due versioni: ancoraggio su muratura e ancoraggio diretto su muro con cappotto isolante.

# FINISHING - FINITURE

## FINISHING

All our finishing are made with the powder coating. All our certified Arteferro System products can be powder coated. Powder coating is a metallic surface covering procedure, which is obtained through an organic film, that is created both for decorative purpose and as protection from corrosion and aggressive agents. If steel items are placed outside, it is recommended to sand-blast and galvanize them before painting. All colours of the RAL colour chart are available, and also some special finishes that we produce with our team of expert varnishers.

## LE FINITURE

Tutte e nostre finiture sono realizzate tramite verniciatura a polvere. Tutti i sistemi certificati Arteferro possono essere verniciati a polveri. La verniciatura a polveri è un procedimento di rivestimento delle superfici metalliche con un film organico, effettuato sia a scopo decorativo sia a scopo di protezione dalla corrosione e dagli agenti aggressivi. Se i prodotti in ferro sono destinati ad uso esterno è consigliabile richiedere che siano sabbiati e zincati prima della verniciatura. Sono disponibili tutti i colori della cartella RAL, più alcune finiture speciali su richiesta che realizziamo grazie al nostro team di maestri verniciatori.

The required products, before being painted, are first subjected to a spray-metallization treatment which guarantees a greater resistance to atmospheric agents over time.

I prodotti richiesti prima di essere verniciati vengono prima sottoposti ad un trattamento di metallizzazione a spruzzo che garantisce una maggiore resistenza agli agenti atmosferici nel tempo.

## FINISHING FINITURE



01  
Raw  
Grezzo



02  
Metallisation arcspray process  
Metallizzato

## STANDARD PAINTING VERNICIATURE STANDARD

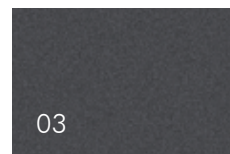

03  
Anthracite  
Antracite

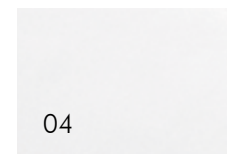

04  
White  
Bianco

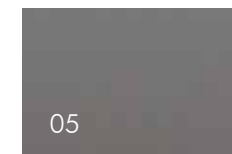

05  
Grey  
Grigio

## SPECIAL PAINTING VERNICIATURE SPECIALI

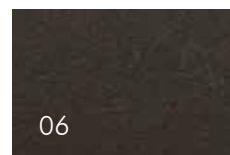

06  
Ancient bronze  
bronzo antico

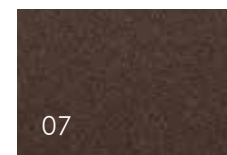

07  
Cor-ten

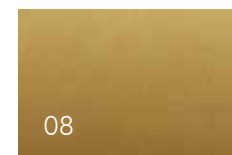

08  
Gold  
Oro

In addition to the colors shown here, the full RAL range is available  
Oltre ai colori qui riportati È disponibile tutta la gamma RAL

[www.coloriral.it](http://www.coloriral.it)

# THE STRUCTURE AND NEWEL POSTS

## LA STRUTTURA E I MONTANTI

The Arteferro certified system is composed of a structural core formed by 2 posts, a customizable handrail depending on the structure made to provide safety but also aesthetic harmony. The certified clamps can be adapted to 3 different types of post: flat, round or square.

Il sistema certificato Arteferro è composto da un'anima strutturale formata da 2 montanti ed un corrimano personalizzabile a seconda della struttura composta per fornire sicurezza ma anche armonia estetica. Le pinze certificate si possono adattare a 3 diversi tipi di montanti: piatto, tondo o quadrato.

### FLAT POST MONTANTE PIATTO

Tube flat handrail  
Corrimano piatto in tubo  
60 x 20 mm



Wall anchorage  
Ancoraggio a muro

Floor anchorage  
Ancoraggio a pavimento

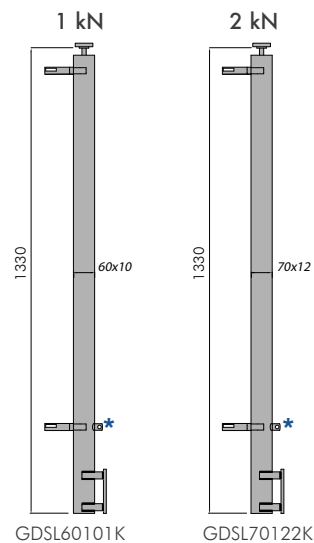
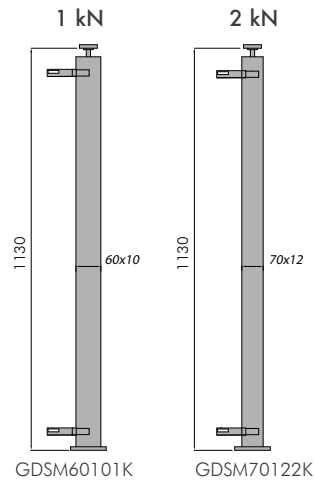

### SQUARE POST MONTANTE QUADRATO

Tube flat handrail  
Corrimano piatto in tubo  
60 x 20 mm



Wall anchorage  
Ancoraggio a muro

Floor anchorage  
Ancoraggio a pavimento

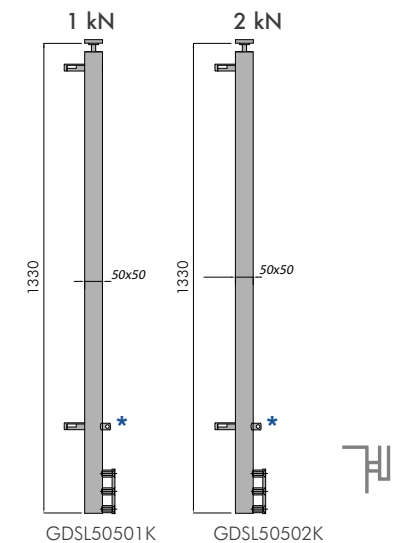
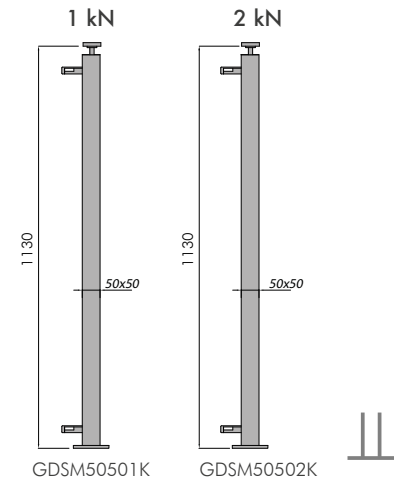

! For the handrail item number see page 58  
Per il codice del corrimano si veda pag. 58



**ROUND POST  
MONTANTE TONDO**

Tube flat handrail  
Corrimano piatto in tubo  
60 x 20 mm



Wall anchorage  
Ancoraggio a muro

Floor anchorage  
Ancoraggio a pavimento

! For the handrail item number see page 58  
Per il codice del corrimano si veda pag. 58

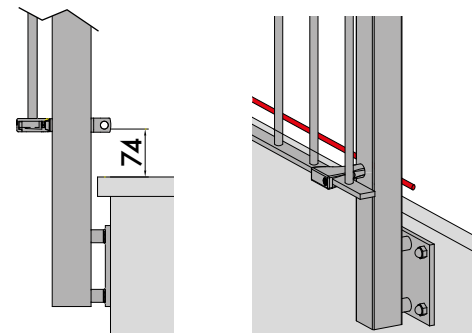
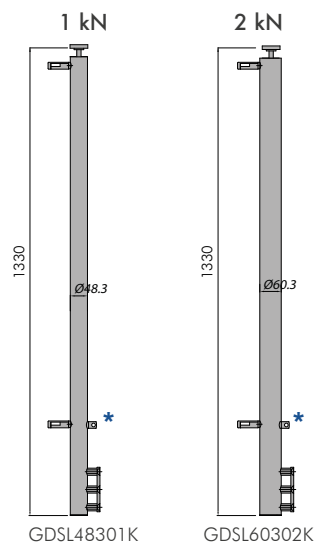
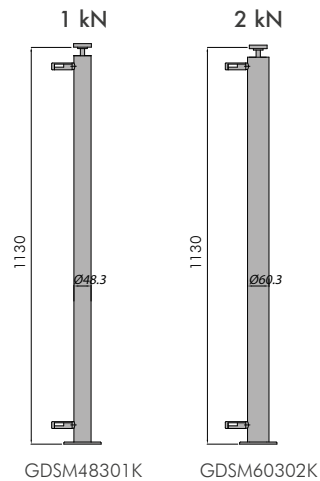

\* SAFETY DETAIL OF LATERAL ANCHORAGE  
DETTAGLIO DI SICUREZZA ANCORAGGIO LATERALE

In order to meet the safety criteria provided by the various and increasingly limiting regulations, in case of lateral anchorage it will be necessary to insert the safety round bar Ø 12 mm. The round bar, in fact, installed at the correct distance, canceled or prevents the possibility of falling.

Al fine di soddisfare i criteri di sicurezza previsti dalle diverse e sempre più limitanti normative, in caso di ancoraggio laterale si renderà necessario l'inserimento di un tondino di sicurezza di Ø 12 mm. Il tondino, infatti, installato alla corretta distanza, annulla o impedisce la possibilità di caduta.

**ANCHORAGE WITH CLAMP FOR BALCONY  
ANCORAGGIO SOLO PINZA PER BALCONI**

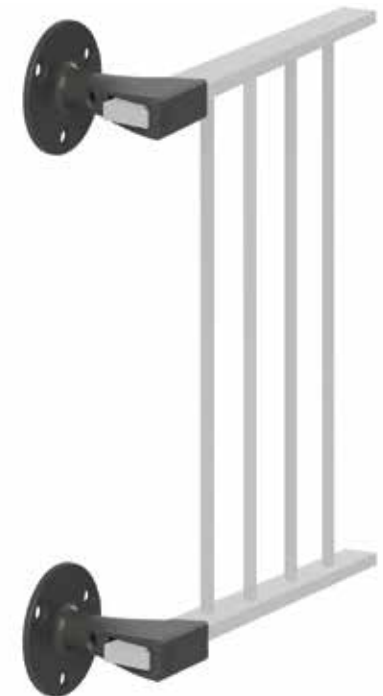

We supply the Arteferro System kit for direct anchoring on wall also with insulating coating.  
See page 58.



Forniamo il kit di Arteferro System per ancoraggio diretto su muro anche con cappotto isolante.  
Si veda pagina 58.

THE PANELS  
I PANNELLI





# SIRMIONE



To download the 3D-block file:  
Per scaricare il blocco 3D:

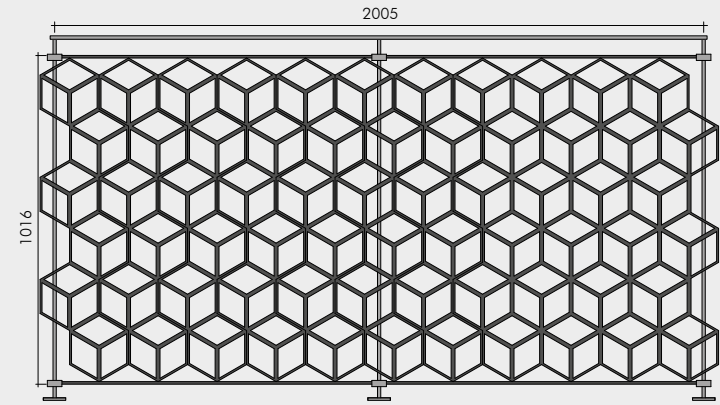
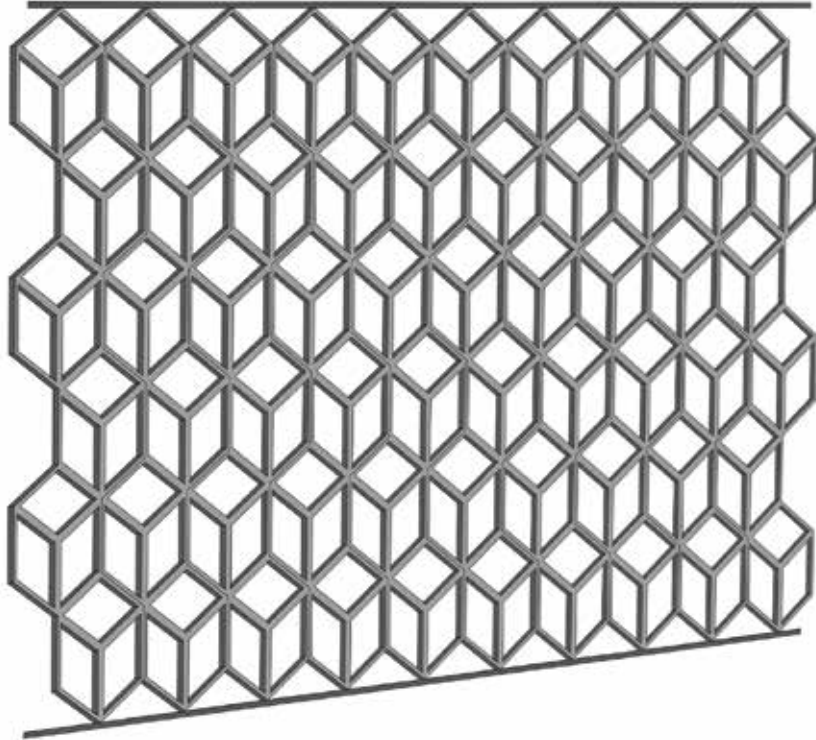

railing applications  
applicazione per parapetti

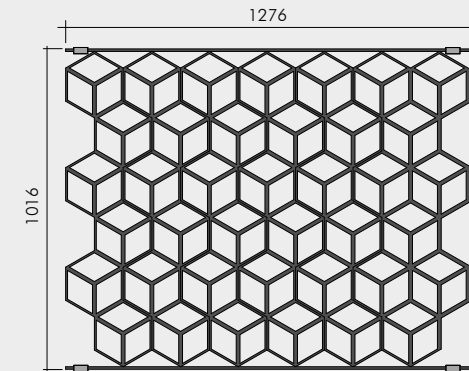

balcony applications  
applicazione per balconi

USE - UTILIZZO

ANCHORING - ANCORAGGIO



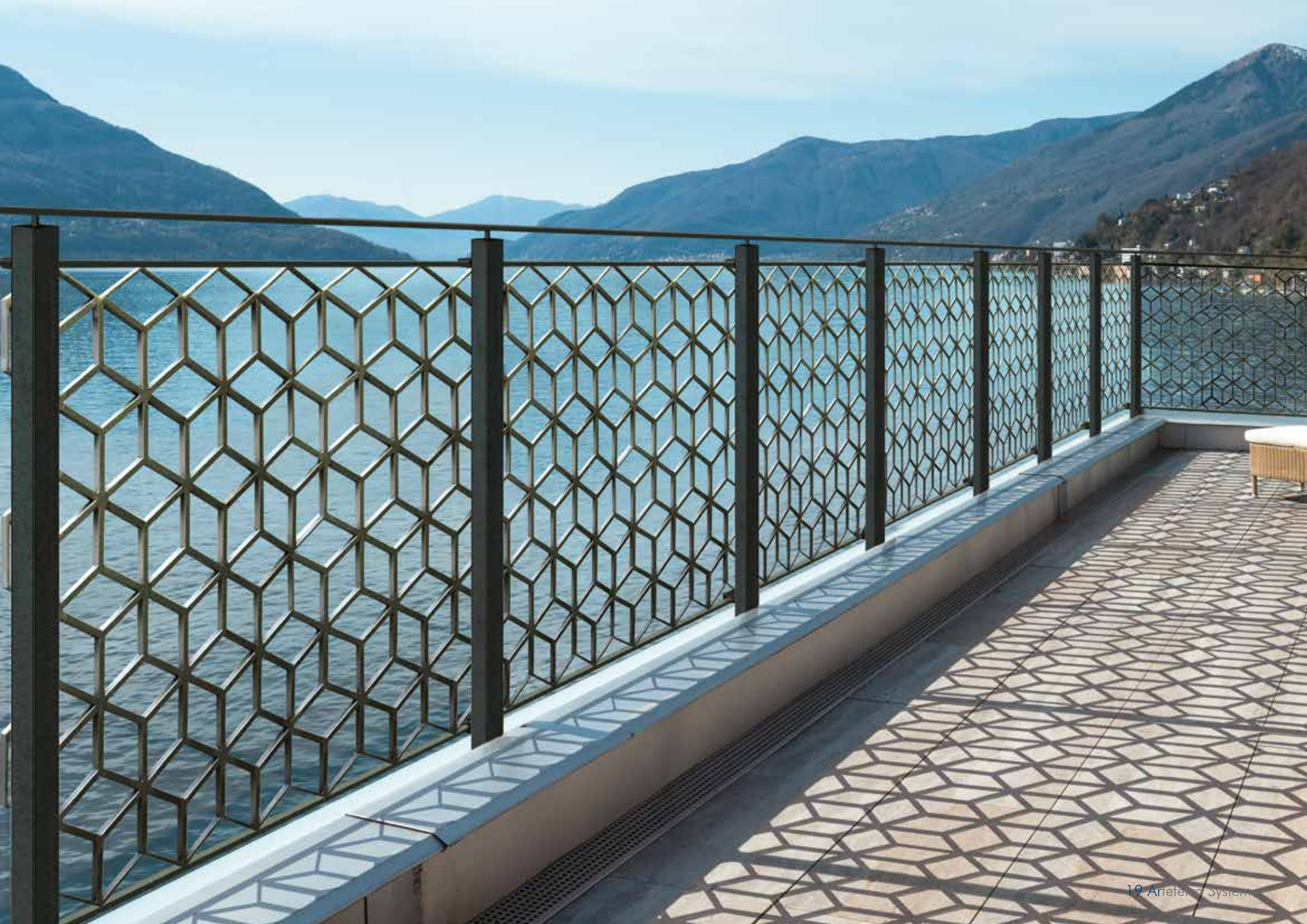

# FIRENZE



To download the 3D-block file:  
Per scaricare il blocco 3D:

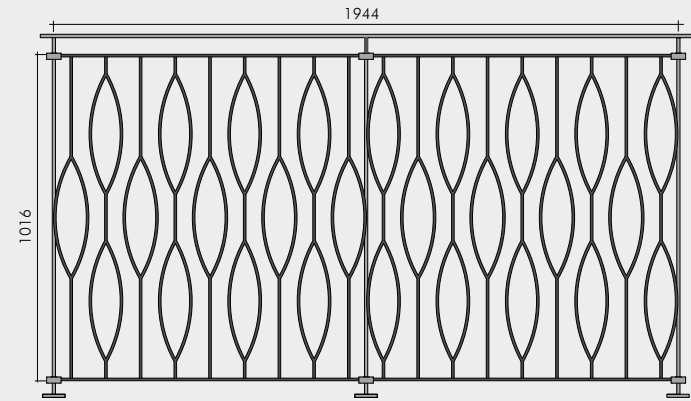
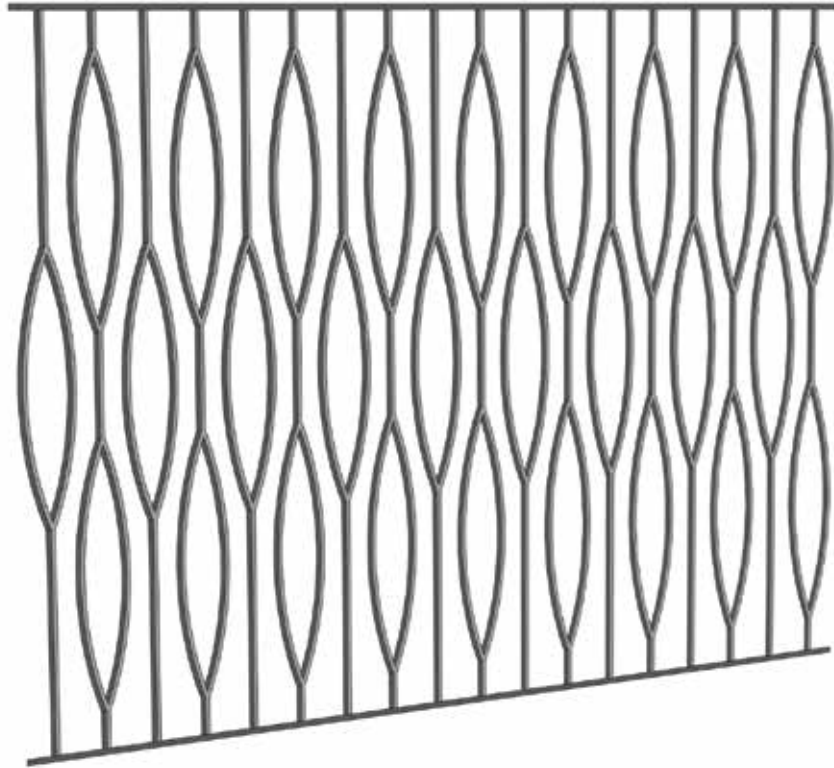

railing applications  
applicazione per parapetti

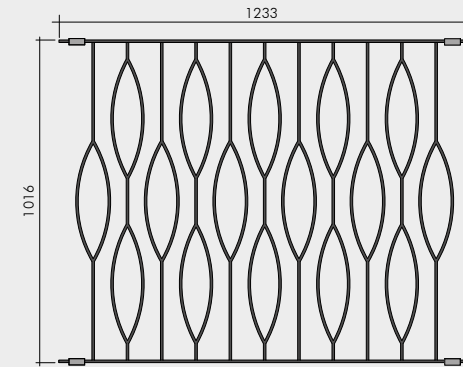

balcony applications  
applicazione per balconi



The image is purely indicative and does not represent the system  
L'immagine è puramente indicativa e non rappresenta il sistema

USE - UTILIZZO

ANCHORING - ANCORAGGIO





# TRIESTE



To download the 3D-block file:  
Per scaricare il blocco 3D:

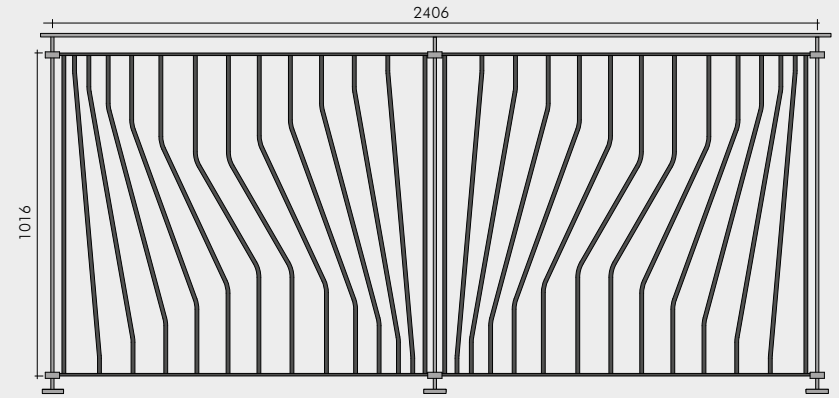
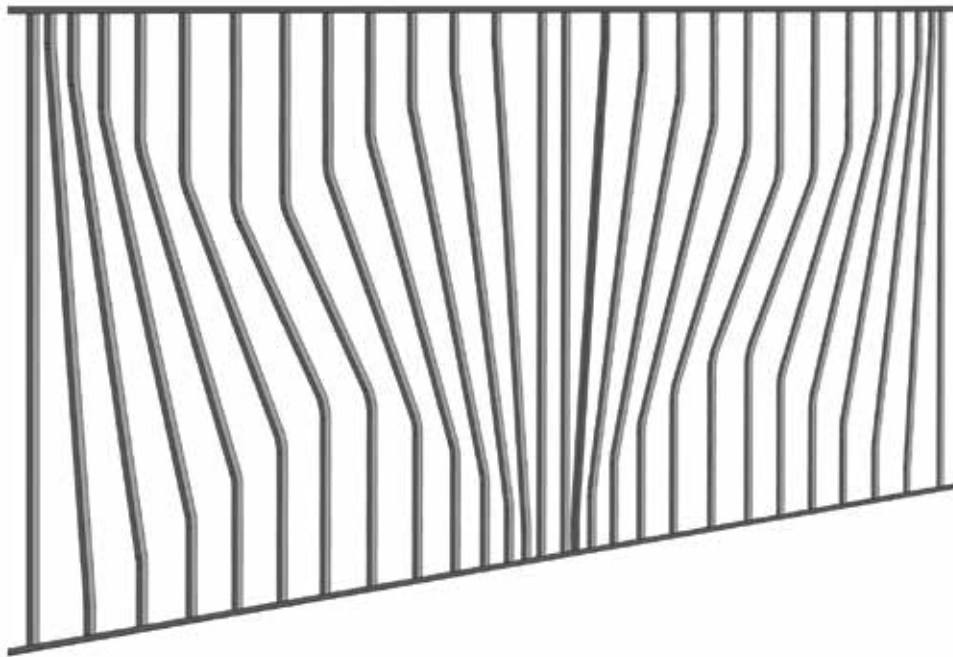

railing applications  
applicazione per parapetti

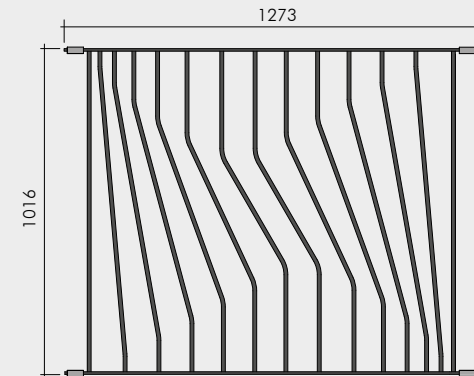

balcony applications  
applicazione per balconi

USE - UTILIZZO

ANCHORING - ANCORAGGIO







# ROMA



To download the 3D-block file:  
Per scaricare il blocco 3D:

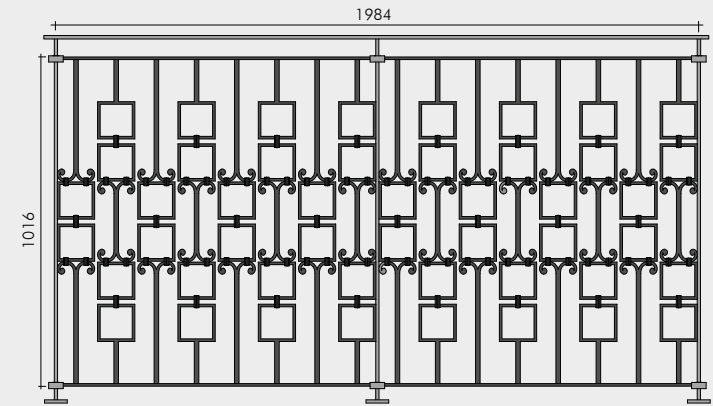
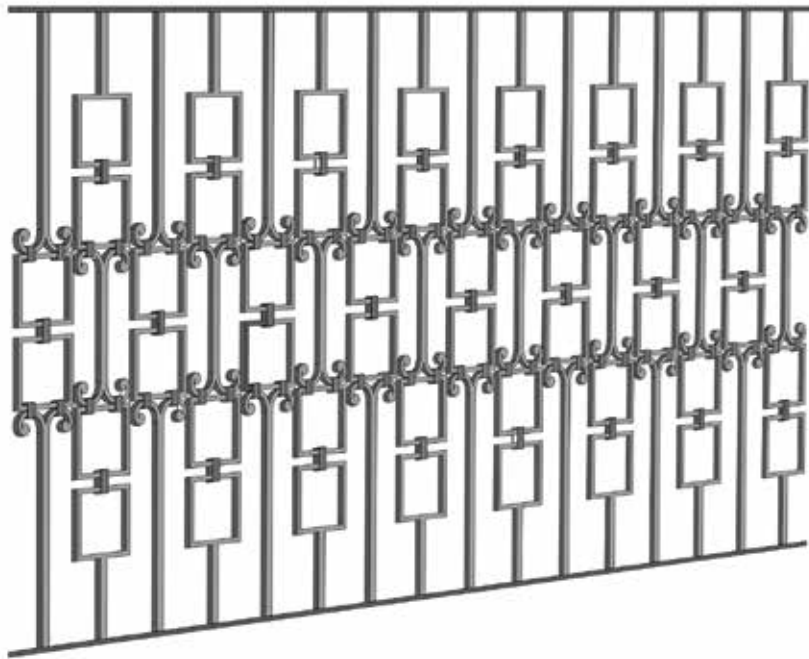

railing applications  
applicazione per parapetti

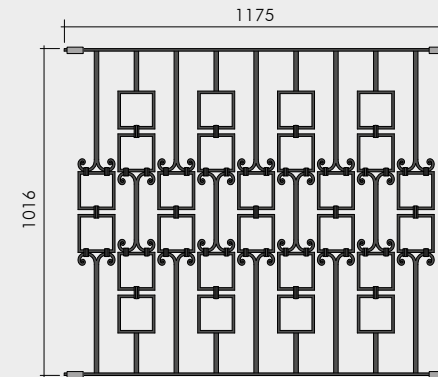

balcony applications  
applicazione per balconi

USE - UTILIZZO

ANCHORING - ANCORAGGIO





# BOLZANO



To download the 3D-block file:  
Per scaricare il blocco 3D:

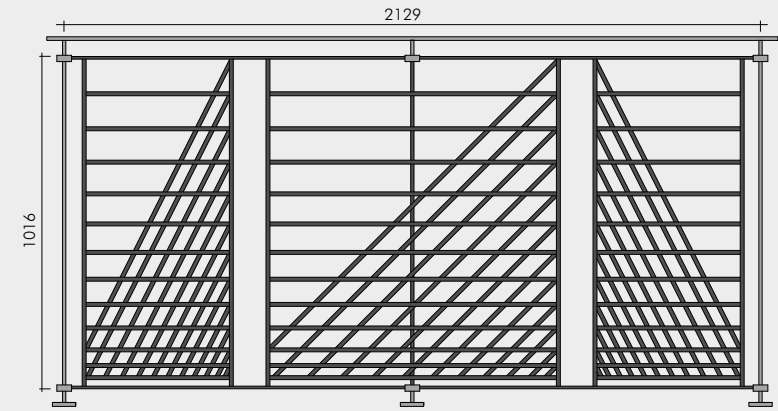
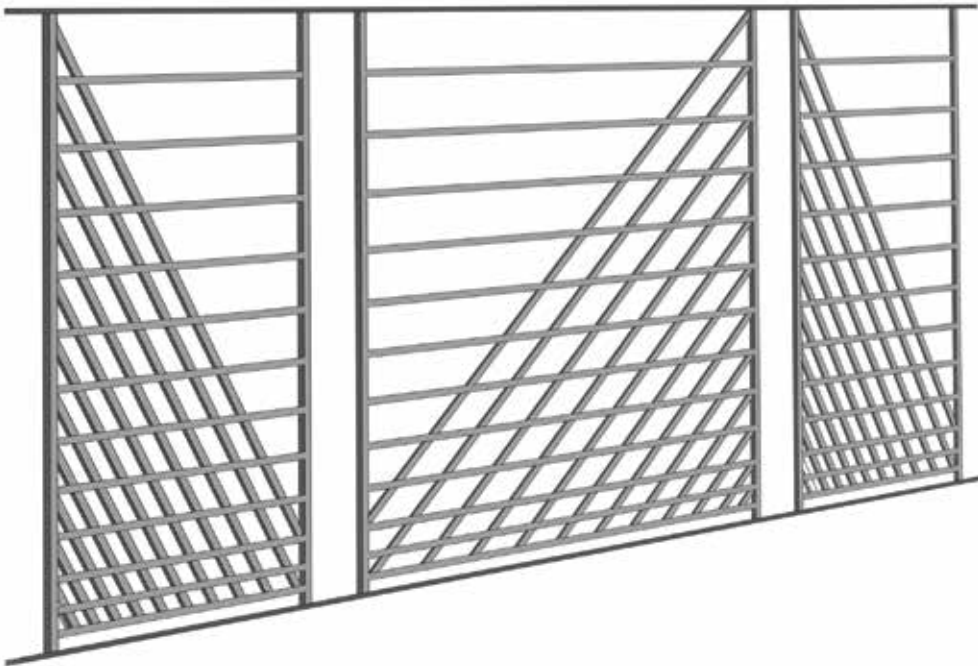

railing applications  
applicazione per parapetti

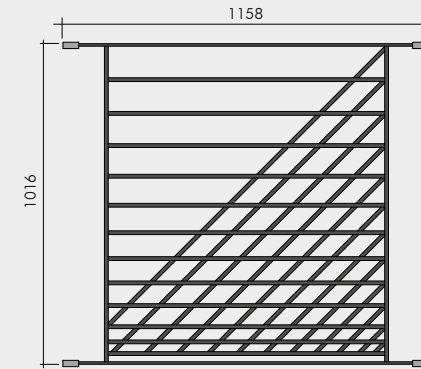

balcony applications  
applicazione per balconi



The image is purely indicative and does not represent the system  
L'immagine è puramente indicativa e non rappresenta il sistema

USE - UTILIZZO

ANCHORING - ANCORAGGIO



# ORTIGGIA



To download the 3D-block file:  
Per scaricare il blocco 3D:

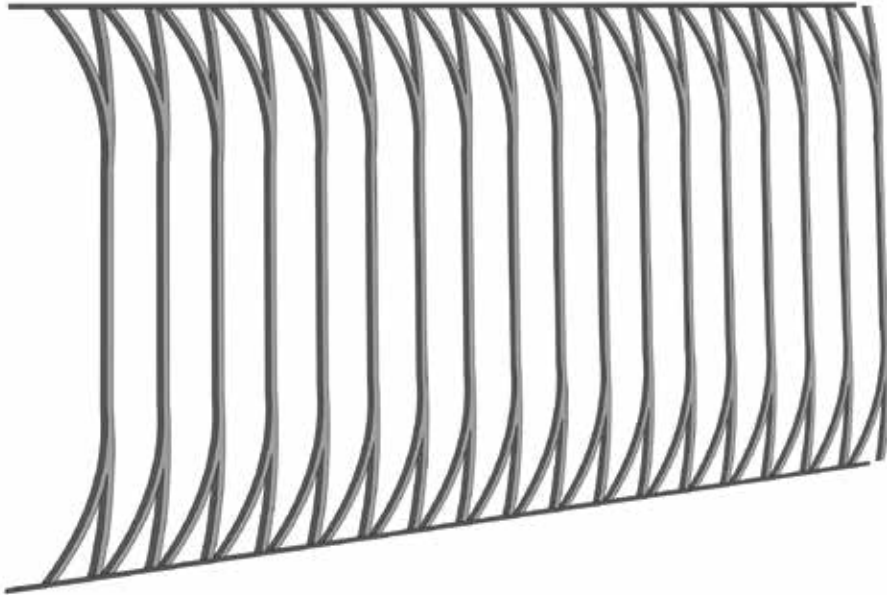

UTILIZZO - USE

ANCORAGGIO - ANCHORING

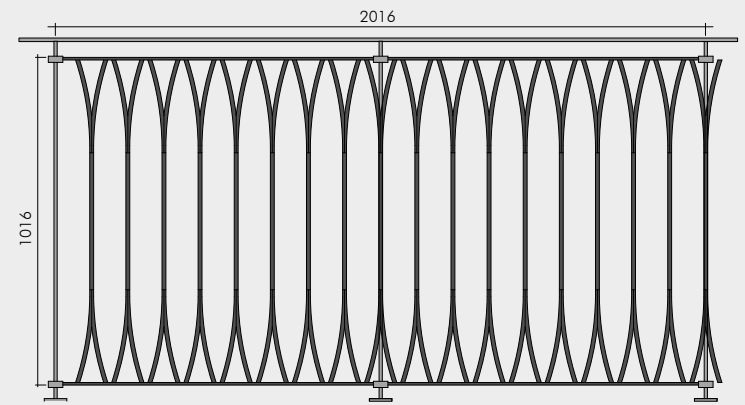

applicazione per parapetti  
railing applications

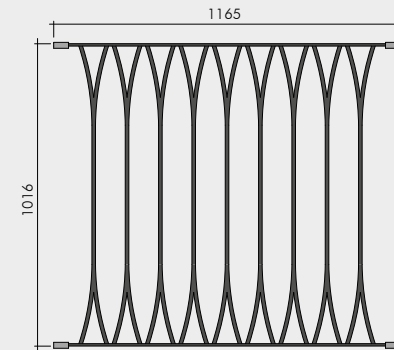

applicazione per balconi  
balcony applications



The image is purely indicative and does not represent the system  
L'immagine è puramente indicativa e non rappresenta il sistema

# PORTOFINO



To download the 3D-block file:  
Per scaricare il blocco 3D:

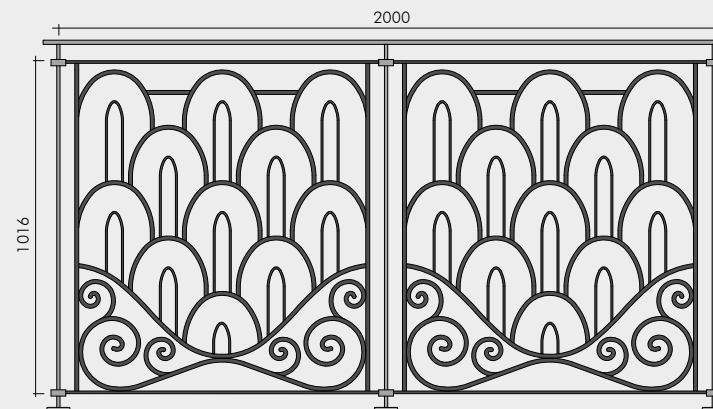
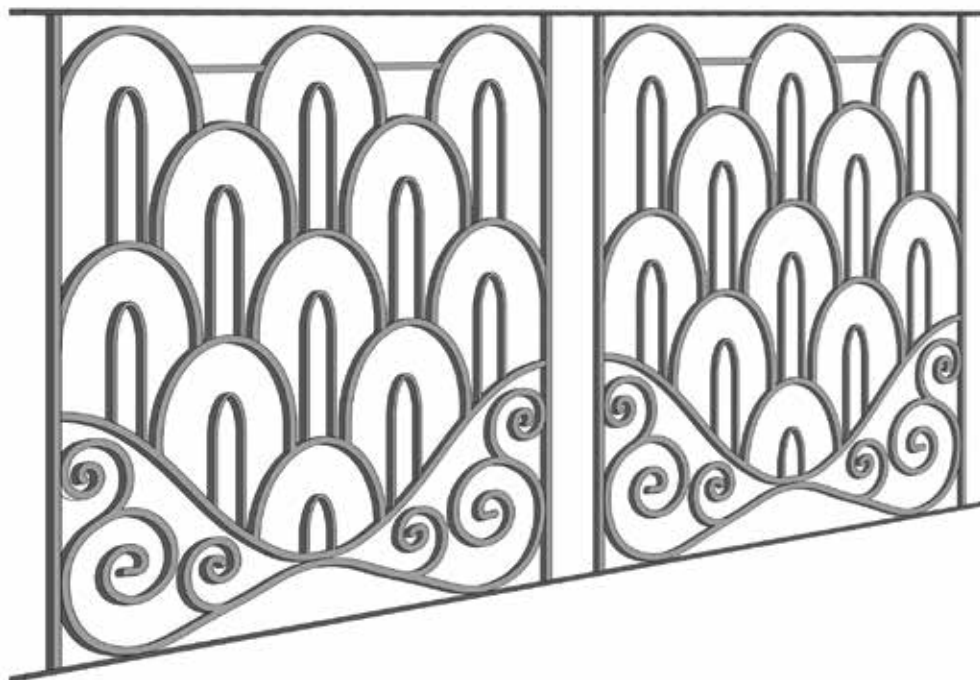

railing applications  
applicazione per parapetti

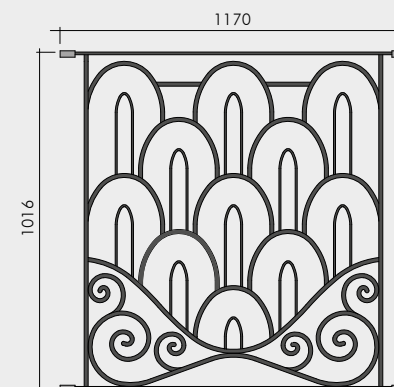

balcony applications  
applicazione per balconi

USE - UTILIZZO

ANCHORING - ANCORAGGIO





# BOLOGNA



To download the 3D-block file:  
Per scaricare il blocco 3D:

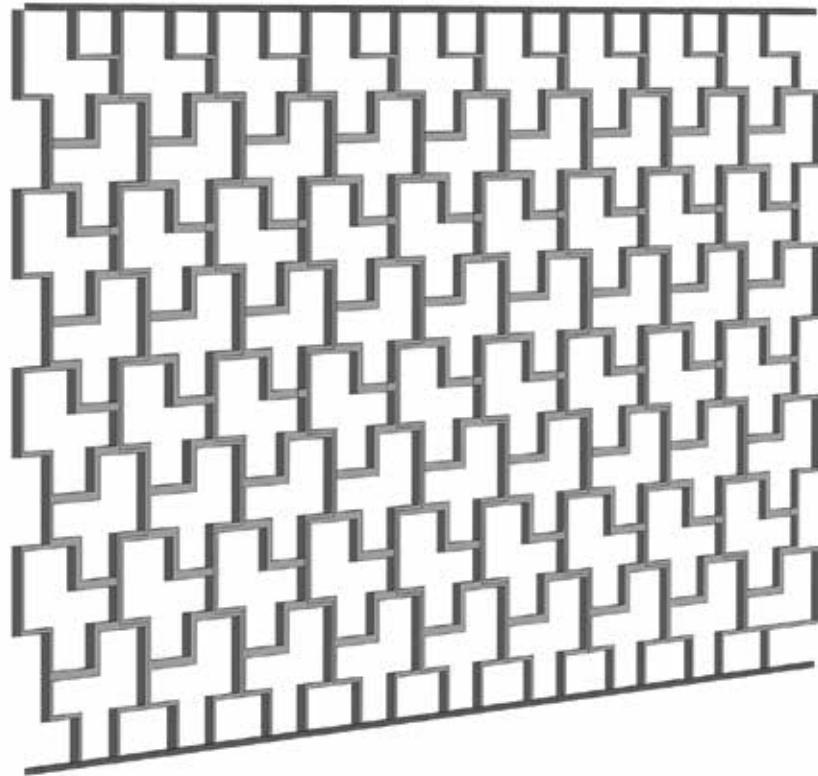

USE - UTILIZZO

ANCHORING - ANCORAGGIO

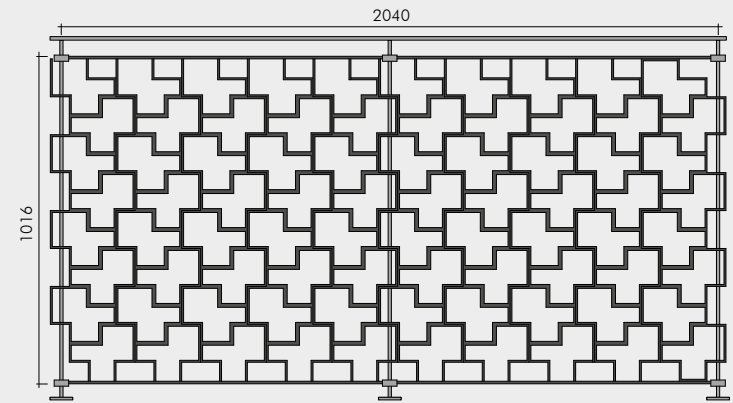

railing applications  
applicazione per parapetti

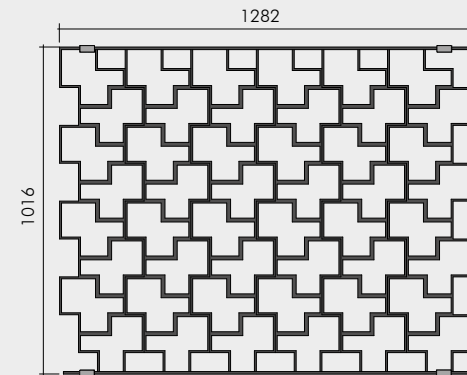

balcony applications  
applicazione per balconi



The image is purely indicative and does not represent the system  
L'immagine è puramente indicativa e non rappresenta il sistema



# STRESA



To download the 3D-block file:  
Per scaricare il blocco 3D:

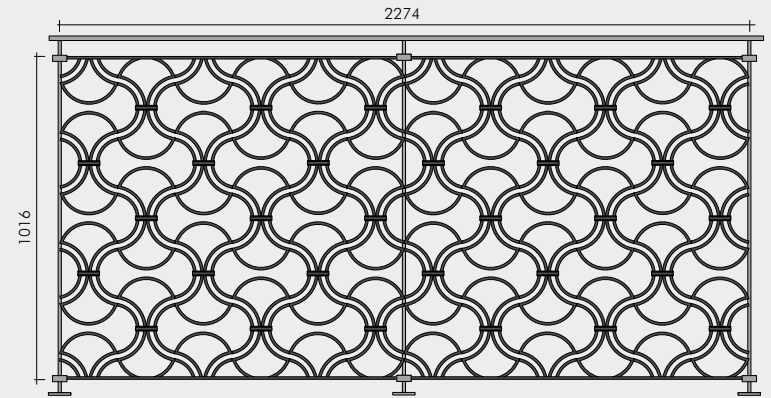
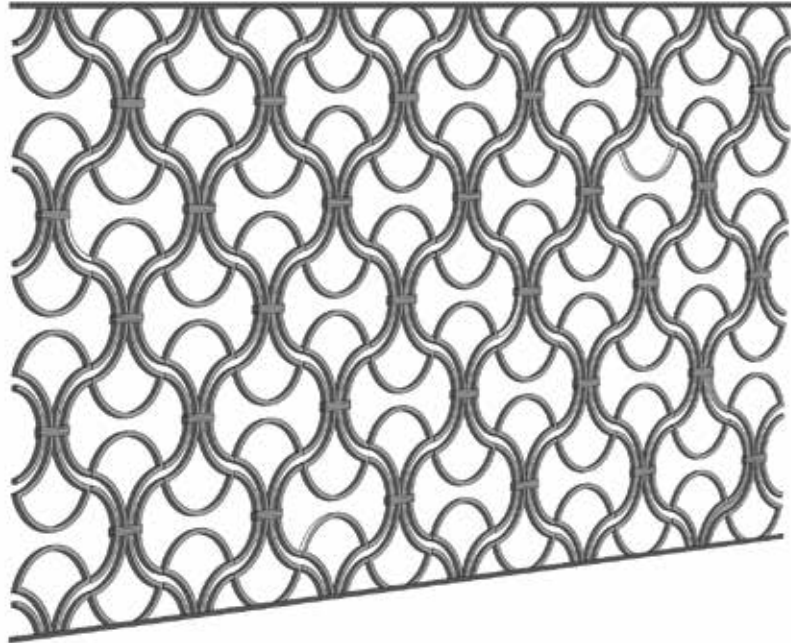

railing applications  
applicazione per parapetti

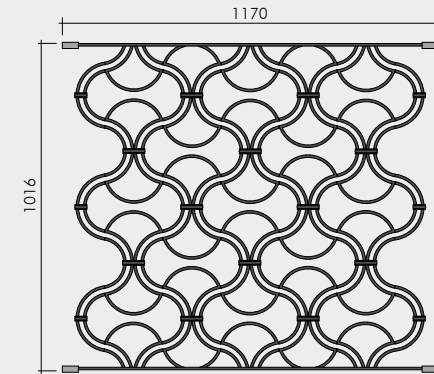

balcony applications  
applicazione per balconi

USE - UTILIZZO

ANCHORING - ANCORAGGIO



The image is purely indicative and does not represent the system  
L'immagine è puramente indicativa e non rappresenta il sistema

# NAPOLI



To download the 3D-block file:  
Per scaricare il blocco 3D:

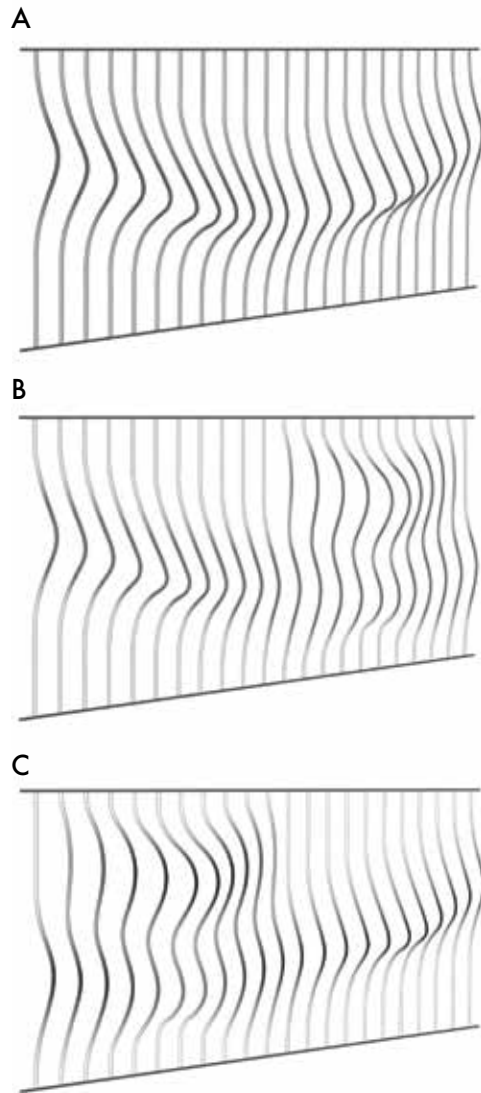

USE - UTILIZZO

ANCHORING - ANCORAGGIO



arteferro

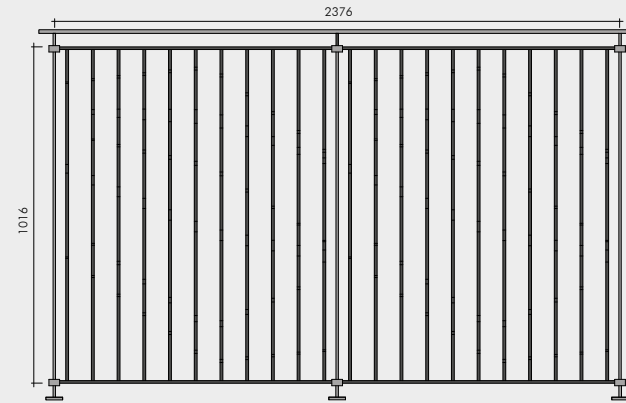

railing applications  
applicazione per parapetti

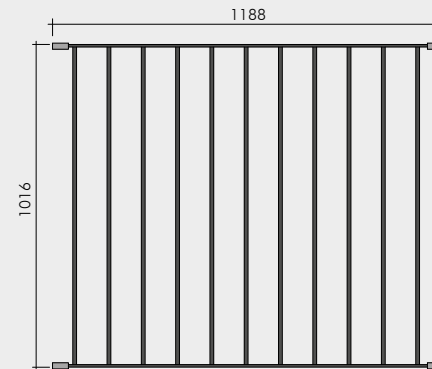

balcony applications  
applicazione per balconi

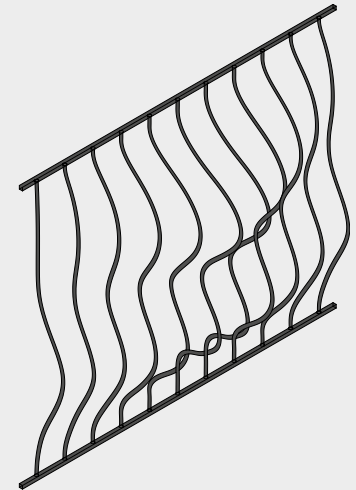

Thanks to the modularity of the elements of our Arteferro System, it is possible to create a unique and personalized design that give you the possibility to have a parapets without repetition.

Grazie alla modularità degli elementi di Arteferro System è possibile avere un design unico e personalizzato che si prolunga all'infinito senza ripetizioni.



# VENEZIA



To download the 3D-block file:  
Per scaricare il blocco 3D:

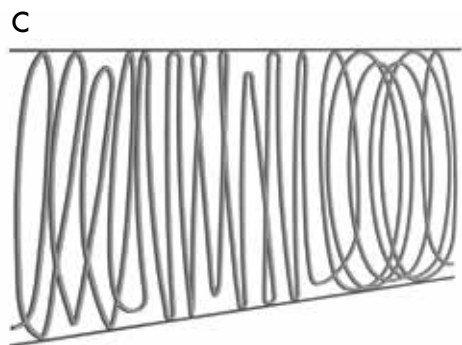
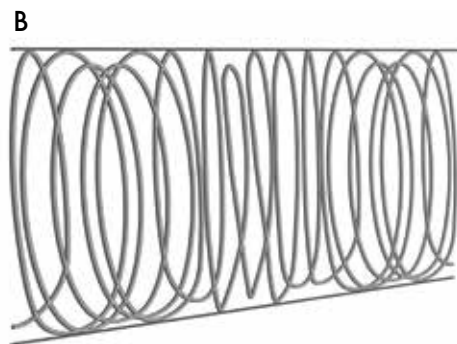
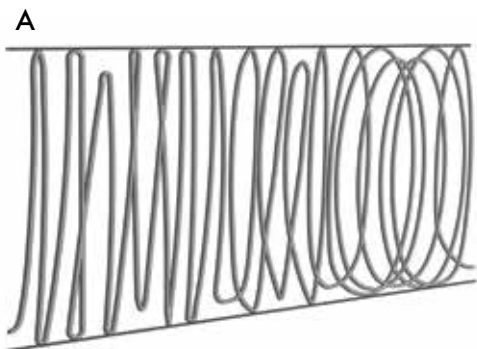

USE - UTILIZZO

ANCHORING - ANCORAGGIO



arteferro

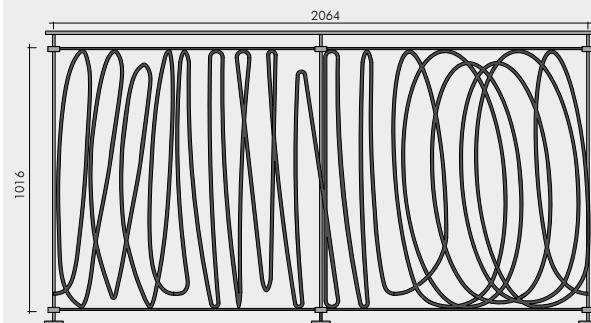
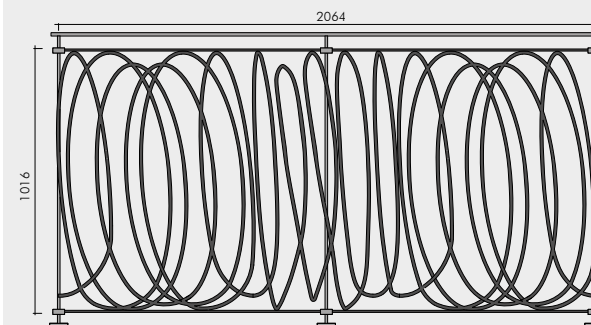
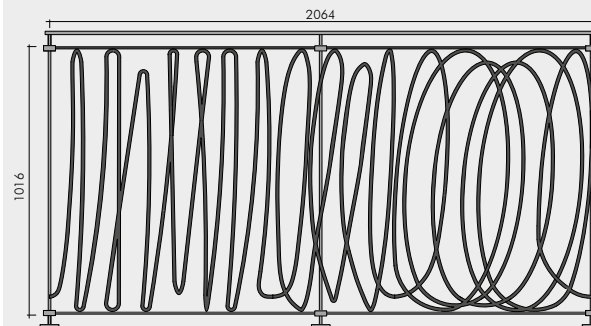

railing applications  
applicazione per parapetti

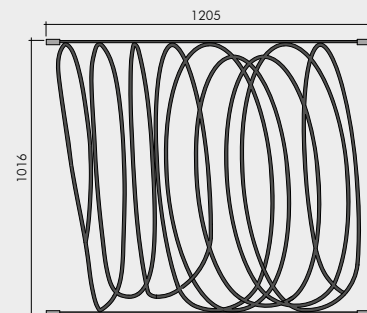
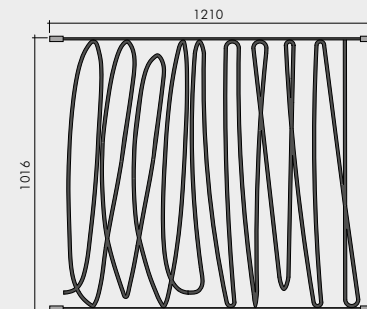

balcony applications  
applicazione per balconi

The following image is purely indicative and does not represent the system  
L'immagine seguente è puramente indicativa e non rappresenta il sistema



# PERUGIA



To download the 3D-block file:  
Per scaricare il blocco 3D:

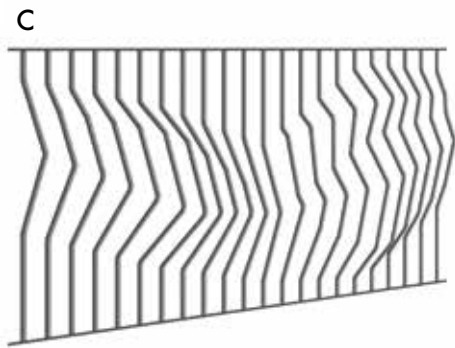
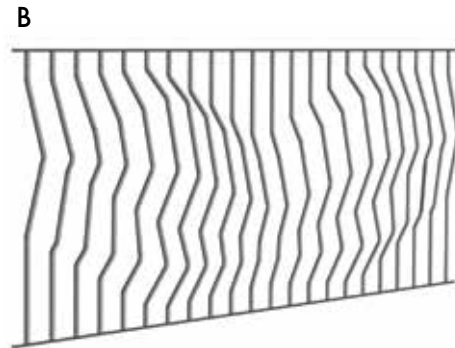
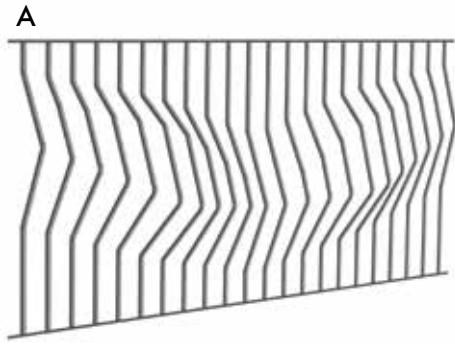

USE - UTILIZZO

ANCHORING - ANCORAGGIO



arterferro

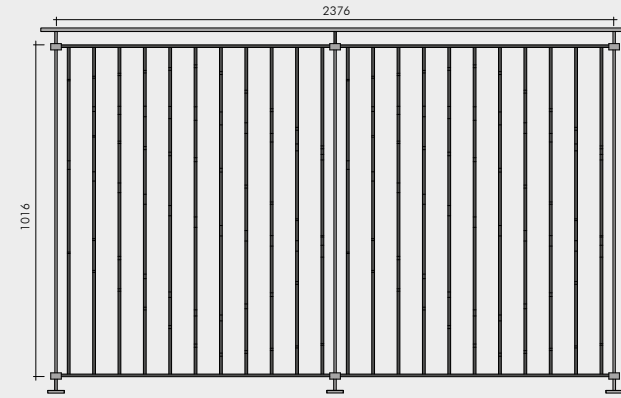

railing applications  
applicazione per parapetti

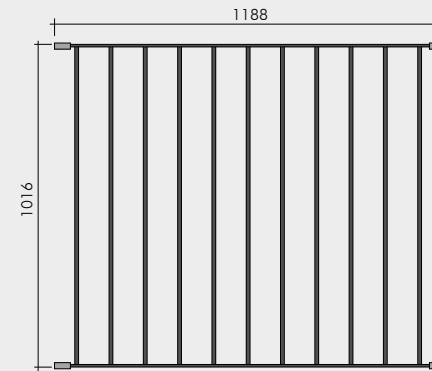

balcony applications  
applicazione per balconi

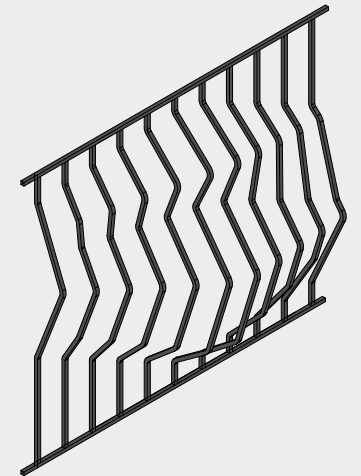

Thanks to the modularity of the elements of our Arterferro System, it is possible to create a unique and personalized design that give you the possibility to have a parapets without repetition.

Grazie alla modularità degli elementi di Arterferro System è possibile avere un design unico e personalizzato che si prolunga all'infinito senza ripetizioni.



# ASCOLI



To download the 3D-block file:  
Per scaricare il blocco 3D:

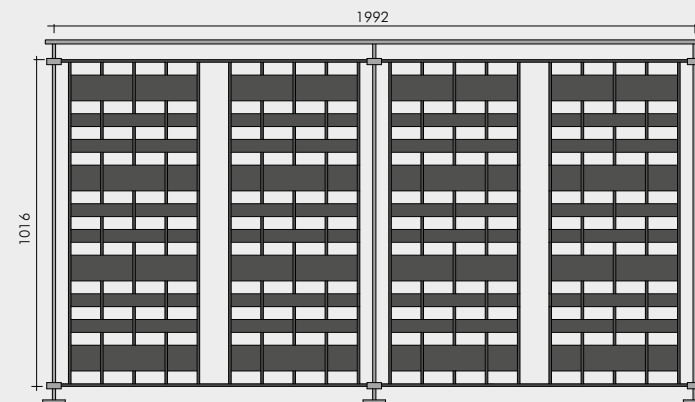
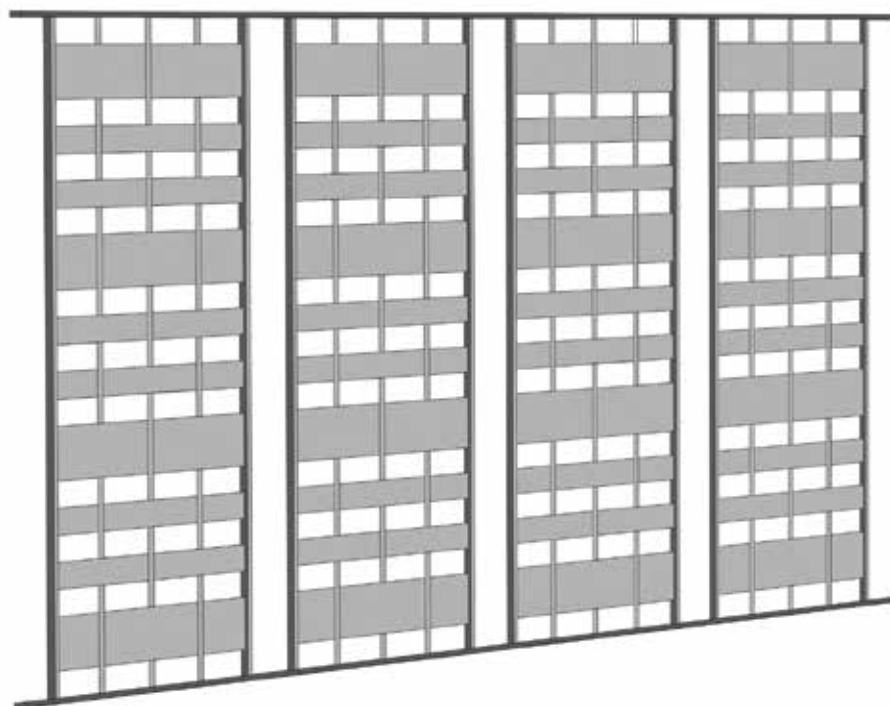

railing applications  
applicazione per parapetti

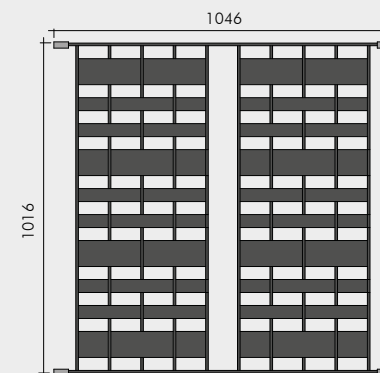

balcony applications  
applicazione per balconi

USE - UTILIZZO

ANCHORING - ANCORAGGIO







# TRANI



To download the 3D-block file:  
Per scaricare il blocco 3D:

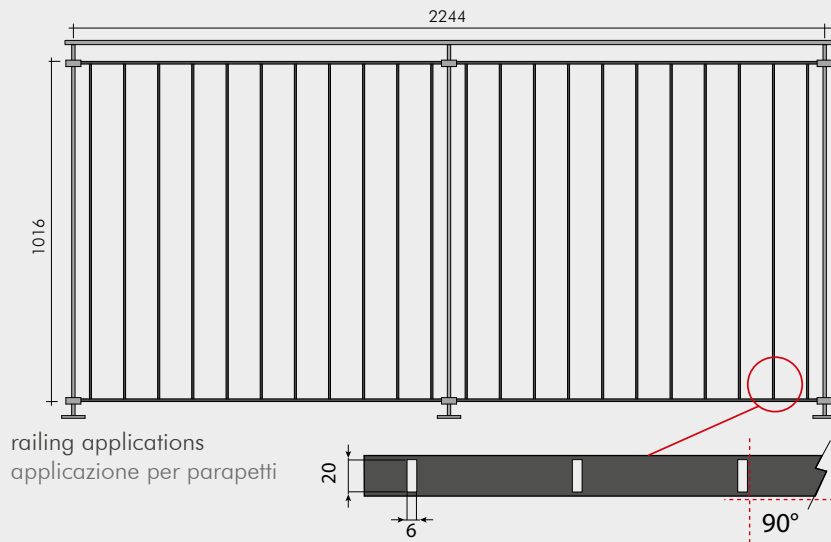
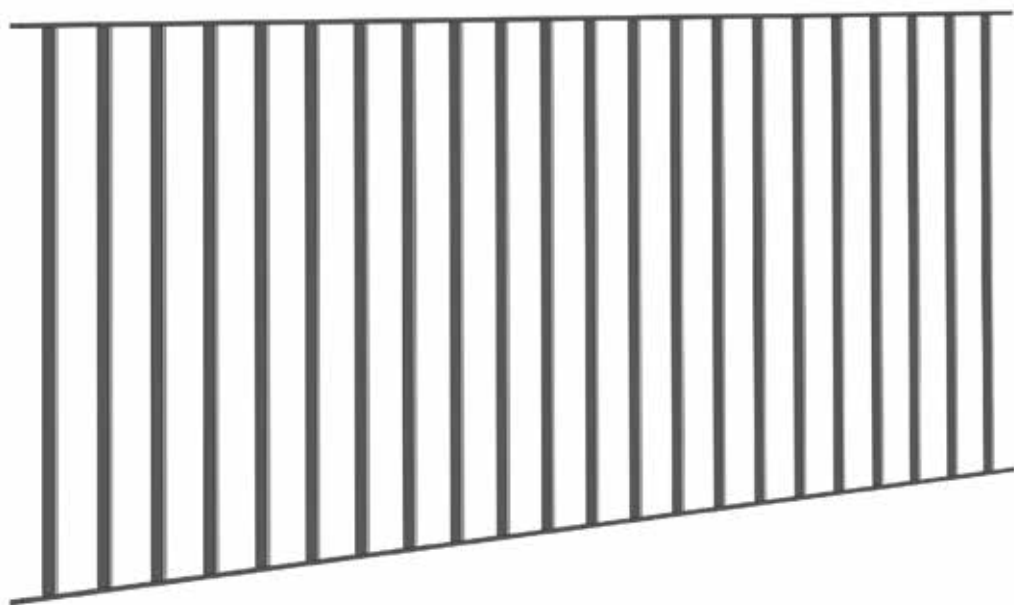

railing applications  
applicazione per parapetti

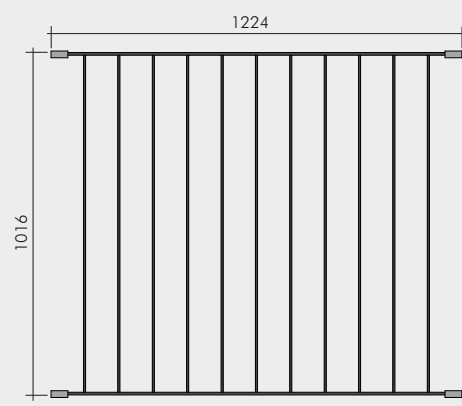

balcony applications  
applicazione per balconi

USE - UTILIZZO

ANCHORING - ANCORAGGIO







To download the 3D-block file:  
Per scaricare il blocco 3D:

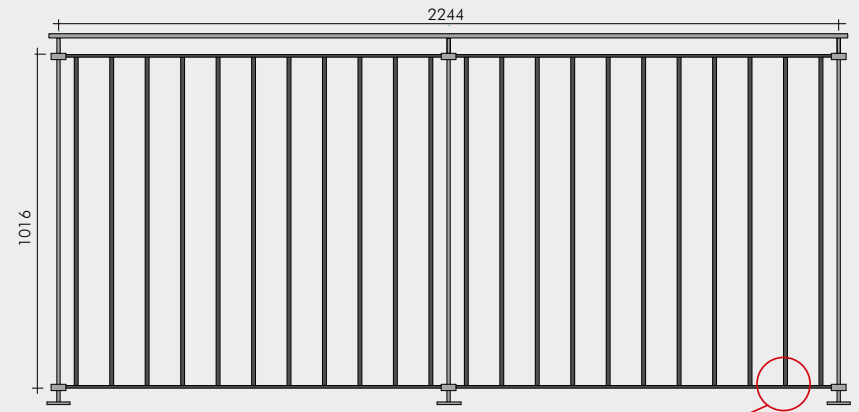
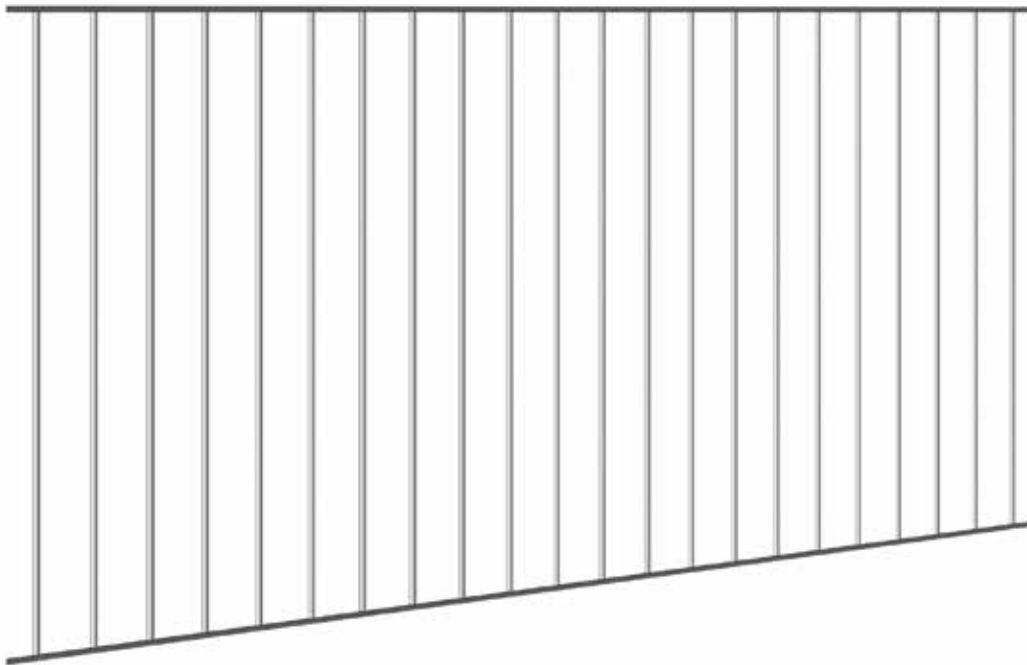

railing applications  
applicazione per parapetti

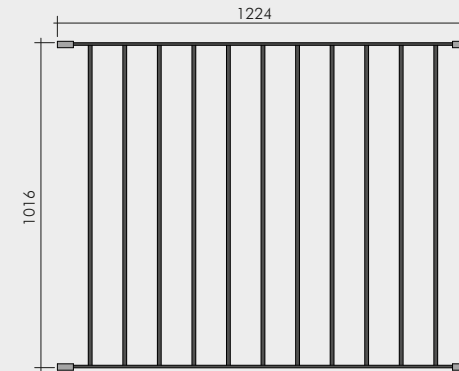

balcony applications  
applicazione per balconi

USE - UTILIZZO

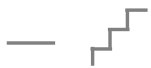

ANCHORING - ANCORAGGIO





# AOSTA



To download the 3D-block file:  
Per scaricare il blocco 3D:

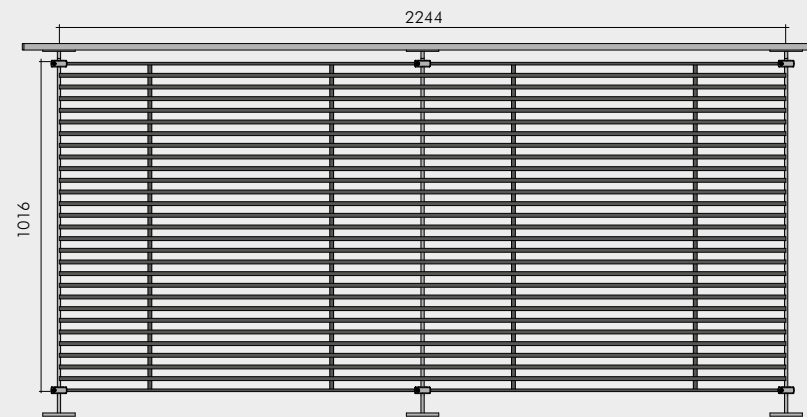

railing applications  
applicazione per parapetti

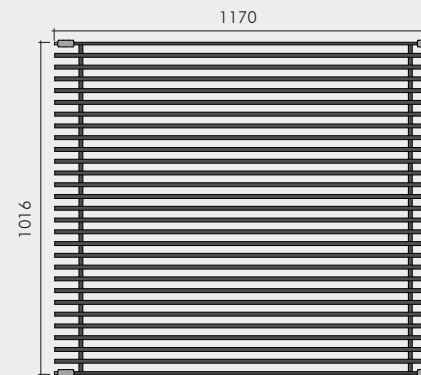

balcony applications  
applicazione per balconi

USE - UTILIZZO

ANCHORING - ANCORAGGIO



arterferro



# JESOLO



To download the 3D-block file:  
Per scaricare il blocco 3D:

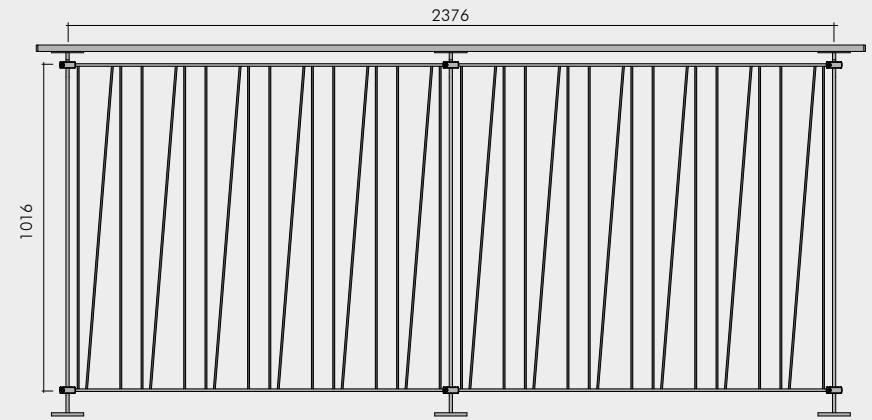
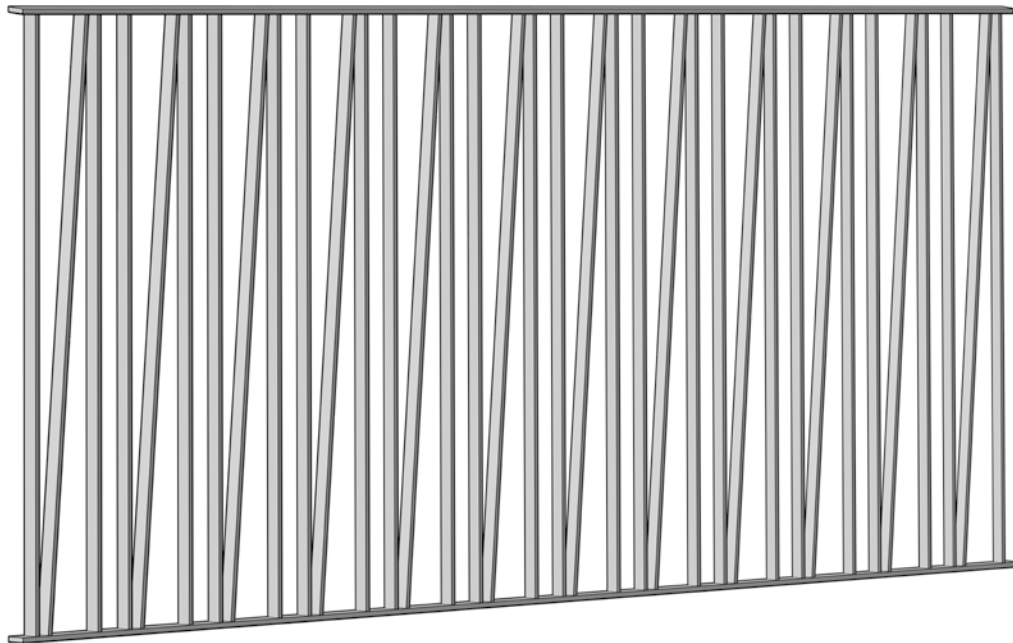

railing applications  
applicazione per parapetti

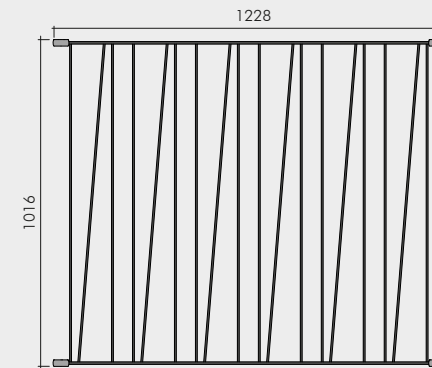

balcony applications  
applicazione per balconi

USE - UTILIZZO

ANCHORING - ANCORAGGIO

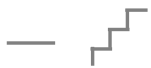





# ISEO



To download the 3D-block file:  
Per scaricare il blocco 3D:

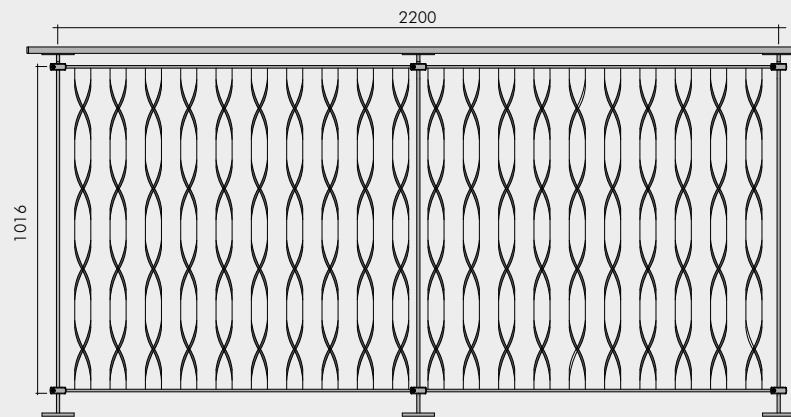
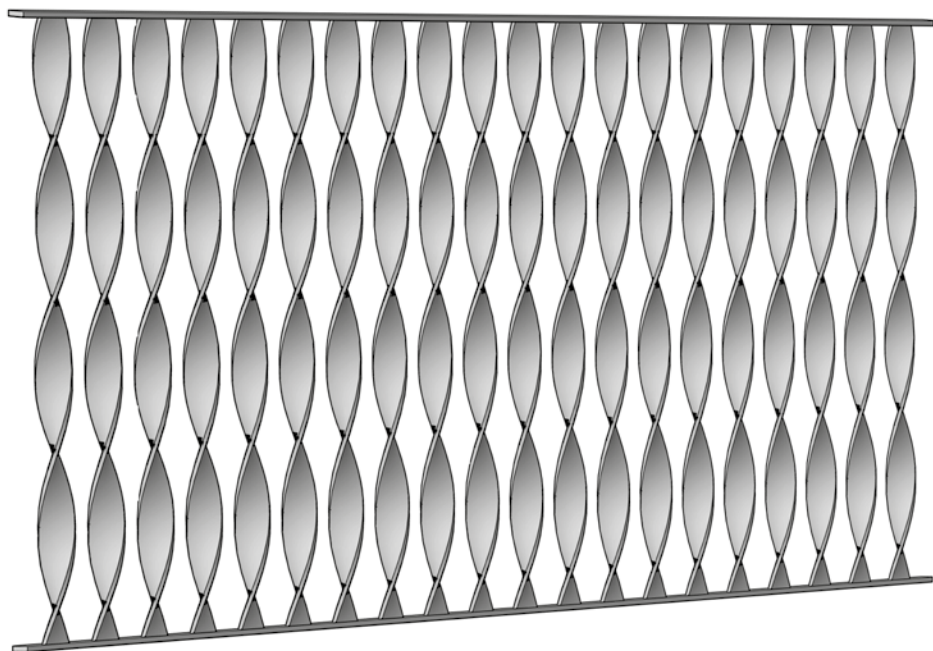

railing applications  
applicazione per parapetti

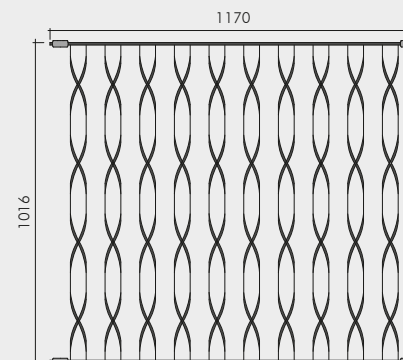

balcony applications  
applicazione per balconi

USE - UTILIZZO

ANCHORING - ANCORAGGIO



arteferro



# TORINO



To download the 3D-block file:  
Per scaricare il blocco 3D:

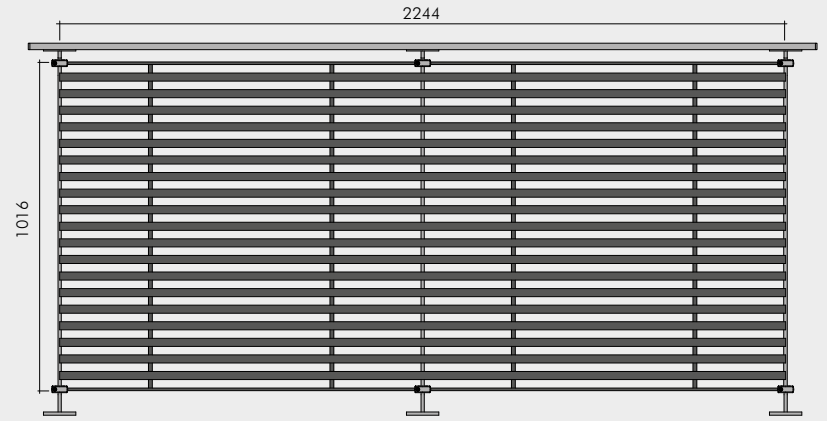
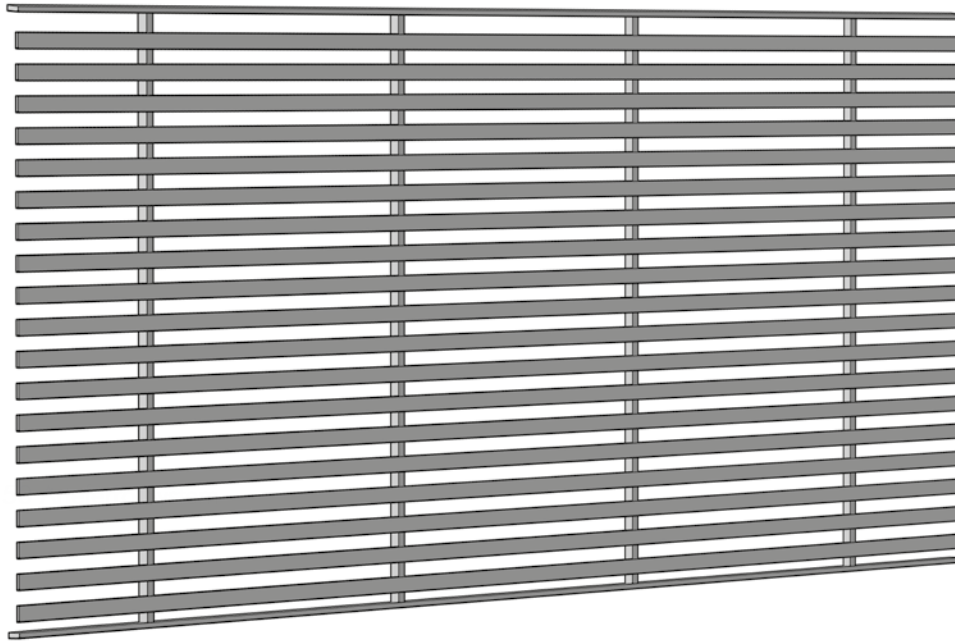

railing applications  
applicazione per parapetti

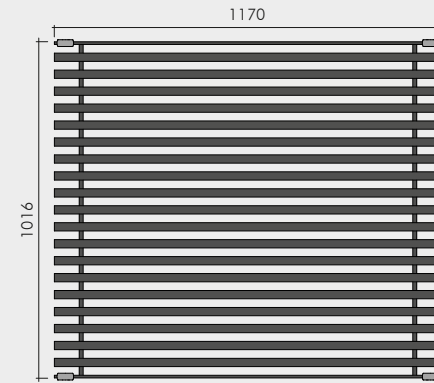

balcony applications  
applicazione per balconi

USE - UTILIZZO

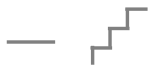

ANCHORING - ANCORAGGIO





# VICENZA



To download the 3D-block file:  
Per scaricare il blocco 3D:

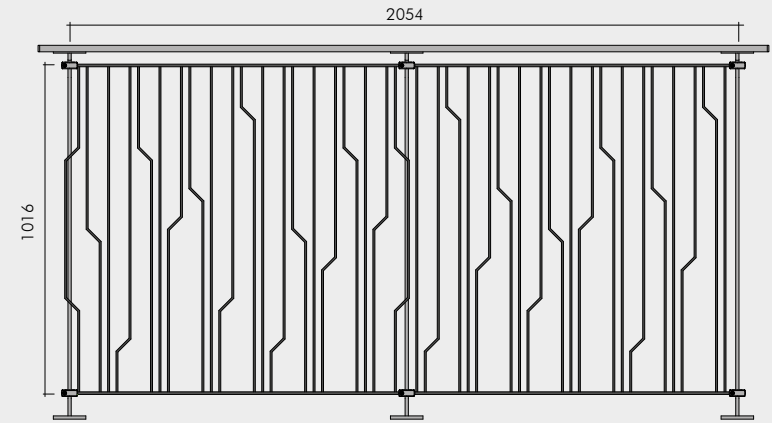
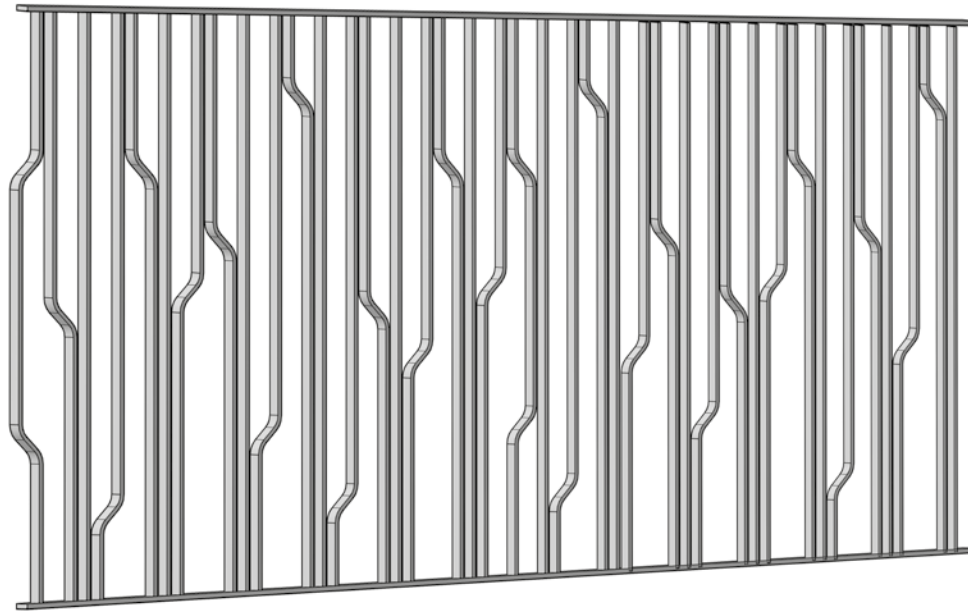

railing applications  
applicazione per parapetti

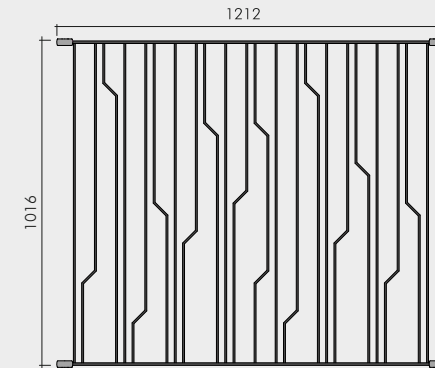

balcony applications  
applicazione per balconi

USE - UTILIZZO

ANCHORING - ANCORAGGIO

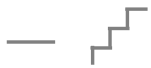



# CORTINA



To download the 3D-block file:  
Per scaricare il blocco 3D:

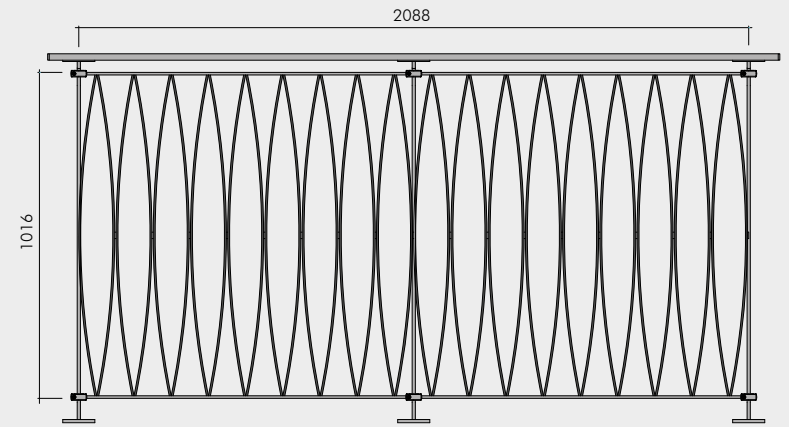
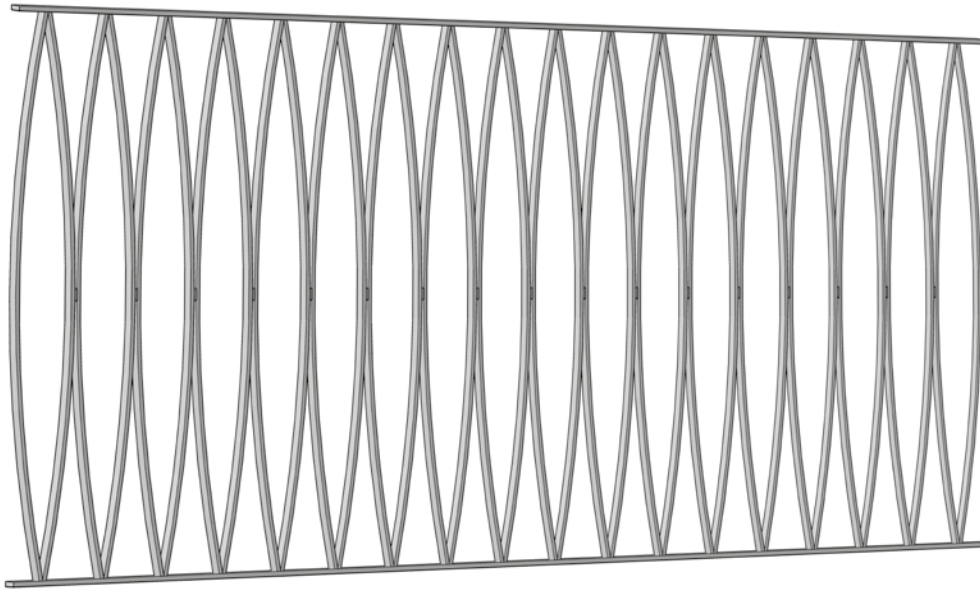

railing applications  
applicazione per parapetti

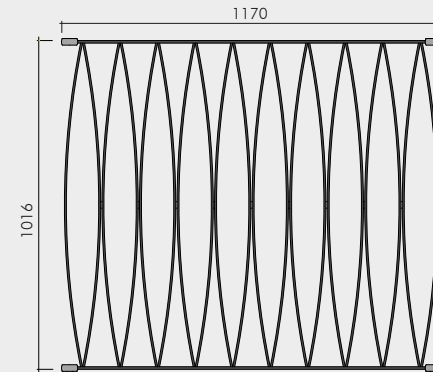

balcony applications  
applicazione per balconi

USE - UTILIZZO

ANCHORING - ANCORAGGIO

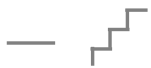





# MILANO



To download the 3D-block file:  
Per scaricare il blocco 3D:

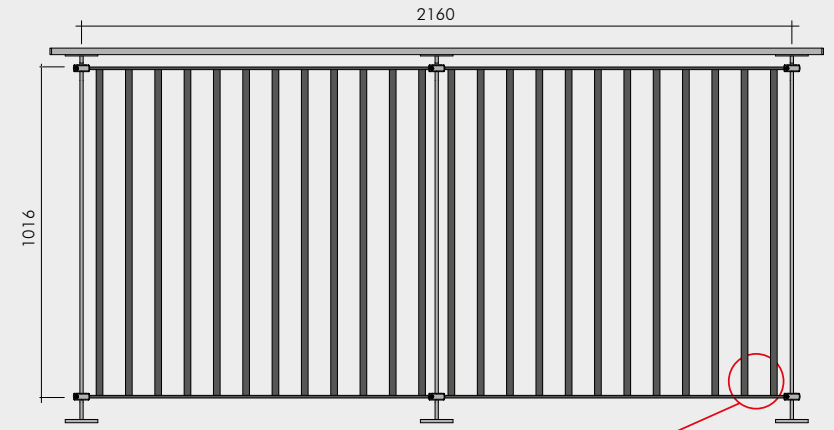
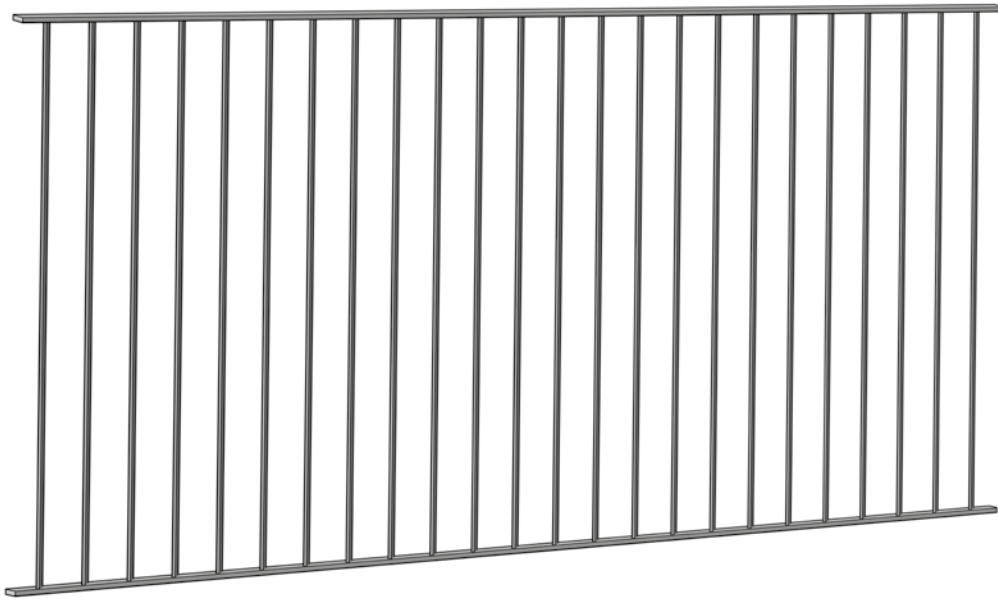

railing applications  
applicazione per parapetti

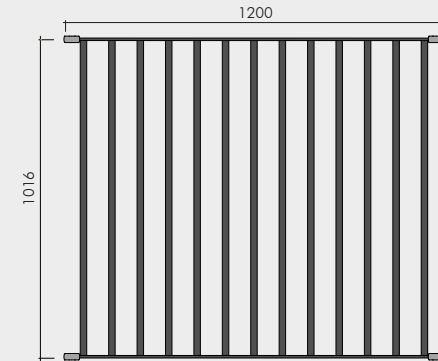
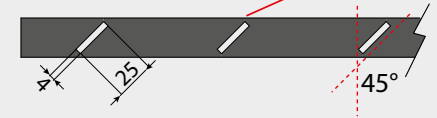

balcony applications  
applicazione per balconi

USE - UTILIZZO

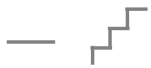









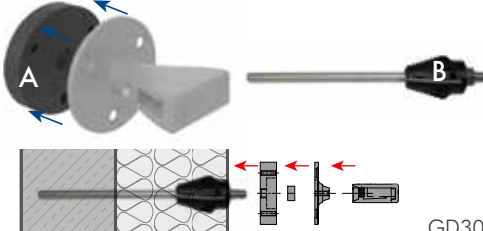
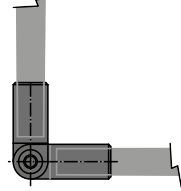



ANCHORING - ANCORAGGIO

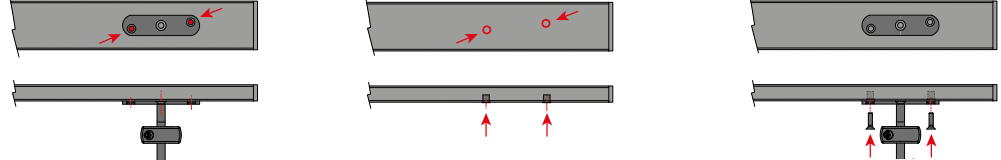



# ACCESSORIES - ACCESSORI

<p>ANCHORAGE WITH CLAMP FOR BALCONY ANCORAGGIO SOLO PINZA PER BALCONI</p>  <p>2600000FB</p>	<p>KIT FOR WALL WITH EXTERNAL THERMAL INSULATION KIT PER MURATURE CON CAPPOTTO ESTERNO</p> <p>A: Spacers B: Dowel for external thermal insulation A: Distanziale B: Tassello per ancoraggio su cappotto termico esterno</p>  <p>GD304</p>	<p>ARTICULATED JOINT SNODO</p> <p>Adjustable Regolabile</p>  <p>Utilizzare solo con attacco laterale Use only with side attachment</p>  <p>Ø12</p> <p>Stainless steel AISI 316 Acciaio inox AISI 316</p> <p>E0170316</p>	<p>ROUND BAR BARRA TONDA</p> <p>Ø 12 mm L 6000 mm</p>  <p>Utilizzare solo con attacco laterale Use only with side attachment</p> <p>Stainless steel AISI 316 Acciaio inox AISI 316</p> <p>E4851/6000</p>	
<p>HANDRAIL CORRIMANO</p> <p>60 x 20 x 2 mm L 6000 mm</p>  <p>Aluminium Alluminio</p> <p>E10006020</p>	<p>CORNER FOR WALL HANDRAIL FIXING ANGOLARE PER FISSAGGIO CORRIMANO A MURO</p>  <p>E08580</p>	<p>THREADED INSERTS FOR RIVETING TOOL INSERTI FILETTATI DA UTILIZZARE CON RIVETTATRICE</p>  <p>E40591 thread-filetto M5</p> <p>Stainless steel AISI 304 Acciaio inox AISI 304</p> <ol style="list-style-type: none"> <li>1 Mark drilling areas Segnare zone di foratura</li> <li>2 Insert E40591 using riveting tool Inserire E40591 utilizzando rivettatrice</li> <li>3 Fissare con ESM545 Fissare con ESM545</li> </ol> 	<p>SCREW M5X20 DIN 7991 AISI316 VITE M5X20 DIN 7991 AISI316</p> <p>M5 x 20 mm</p>  <p>Stainless steel AISI 316 Acciaio inox AISI 316</p> <p>ESM545</p>	
<p>END CAP TAPPO</p> <p>For tube - Per tubo 60 x 20 x 2 mm</p>  <p>Aluminium Alluminio</p> <p>E1100210</p>	<p>ANGULAR CONNECTOR CONNETTORE ANGOLARE</p> <p>For tube - Per tubo 60 x 20 x 2 mm</p>  <p>Aluminium Alluminio</p> <p>E1100230</p>	<p>LINEAR CONNECTOR CONNETTORE LINEARE</p> <p>For tube - Per tubo 60 x 20 x 2 mm</p>  <p>Aluminium Alluminio</p> <p>E1100220</p>	<p>SPRAY ZINC AND LIQUID ZINC ZINCO SPRAY E ZINCO LIQUIDO</p> <p>Spray and liquid zinc kit necessary in case of cutting or finishing of the material. Kit di zinco spray o liquido necessario in caso di taglio o rifinitura del materiale.</p>  <p>185/9</p> <p>185/9/B</p>	<p>PAINTING KIT KIT PER VERNICIATURE</p> <p>Arterferro supplies paints and patinas for finishing your wrought ironwork, both indoors and outdoors. Arterferro mette a disposizione vernici e patine per rifinire al meglio le vostre realizzazioni in ferro battuto, sia in interni che in esterni.</p>  <p>Paint code upon request Codice della vernice su richiesta</p>

# GUARANTEES - GARANZIE

## SANDBLASTING:

Sandblasting is a process used to remove impurities from metals using a jet of sand or other substances with controlled abrasiveness. The jet, with variable pressure, extends the duration of the subsequent painting and of the anti-rust treatments.

In this process, materials of different granulometry are used depending on the result to be obtained.

## SABBIATURA:

La sabbiatura è un procedimento utilizzato per eliminare le impurità dei metalli mediante un getto di sabbia o altre sostanze ad abrasività controllata. Il getto, a pressione variabile, estende la durata della successiva verniciatura e dei trattamenti antiruggine.

In questo processo vengono utilizzati materiali di granulometria differente a seconda del risultato da ottenere.

## METALLISATION ARCSPRAY PROCESS:

Our metallisation arcspray process consists in the application of pure zinc on a metal surface pretreated by sandblasting. The zinc wire is inserted into an acetylene flame spray gun, which vaporizes and deposits in the form of powders. In this way the piece to be treated is completely wrapped in a solid galvanized coating in the thickness required of our standard quality. Metallisation is a rapid method for protection from metal structures from corrosion.

Compared to traditional galvanizing, metallisation has several advantages: avoids the deformation necessary for the heat of the galvanic baths and allows to obtain a well-defined and uniform coating thickness. This is an anchoring substrate for a subsequent coating of powder paint, that greatly increasing its durability, it does not require slag cleaning.

## METALIZZAZIONE:

Il nostro servizio di metallizzazione consiste nell'applicazione di zinco puro su una superficie metallica pretrattata mediante sabbiatura. Lo zinco in filo viene inserito in una pistola a spruzzo a fiamma acetilenica, che lo vaporizza e lo deposita sotto forma di polveri. In questo modo il pezzo da trattare viene interamente avvolto da un solido rivestimento zincato nello spessore richiesto dal cliente. La metallizzazione è un metodo rapido per proteggere i manufatti metallici dalla corrosione. Rispetto alla zincatura tradizionale, la metallizzazione presenta diversi vantaggi: evita la deformazione dovuta al calore dei bagni galvanici permette di ottenere uno spessore di rivestimento ben definito e uniforme costituisce l'ideale substrato di ancoraggio per un successivo rivestimento di vernice in polvere, aumentandone notevolmente la durata nel tempo non necessita di pulizie da scorie.

## GUARANTEES:

Through sandblasting and hot galvanization we can guarantee anti-corrosion, which increases the resistance of the powder coating subsequently applied. The main added value of applied coatings is in the craftsmanship care with which they are performed. All processes are carried out manually by the technicians and check by our quality control before delivery to the customer.

The polymerization of the powders at high temperatures in a static furnace gives to this kind of painting a remarkable adherence to the surfaces.

Among the benefits we can guarantee there are: speed; resistance to chemical agents, reduced environmental impact and a wide range of surface finishes available on stock.

## GARANZIE DELLE FINITURE:

Attraverso i processi di verniciatura possiamo garantire l'anticorrosione, che aumenta la tenuta della vernice a polvere successivamente applicata. Il principale valore aggiunto delle verniciature applicate risiede nella cura artigianale con cui vengono eseguite. Tutte le lavorazioni sono effettuate manualmente dai tecnici e revisionate dal nostro controllo qualità prima della consegna al cliente. La polimerizzazione delle polveri ad alte temperature in forno statico conferisce a questo tipo di verniciatura una notevole aderenza alle superfici.

Tra i benefici che possiamo garantire ci sono: la rapidità; la resistenza agli agenti chimici, il ridotto impatto ambientale, il vasto assortimento di finiture superficiali disponibili a magazzino



To download the 3D-block file:  
Per scaricare il blocco 3D:



**arteferro**  
SYSTEM



# *arteferro*

**SYSTEM**



[arteferro.com](http://arteferro.com)

# SAFE DESIGN FOR PROJECTS

## GONZATO GROUP ITALIA

Ind.i.a. spa  
Via Vicenza, 6/14  
36034 - Malo  
Vicenza • Italia  
tel. +39 0445 580 580 • fax: +39 0445 580 874  
info@india.it • www.india.it

## GONZATO GROUP TEXAS

Indital US Ltd  
7947 Mesa Drive  
77028 - Houston  
Texas • U.S.A.  
tel. +1 713 694 6065 • fax: +1 713 694 2055  
forgings@indital.com • www.indital.com

## GONZATO GROUP FLORIDA

Arteferro Miami LLC  
2955 NW 75th Street  
33147 - Miami  
Florida • U.S.A.  
tel. +1 305 836 9232 • fax: +1 305 836 4113  
info@arteferromiami.com • www.arteferromiami.com

## GONZATO GROUP FRANCE

Ind.i.a. France Sarl  
P.A.E. la Baume, 7 Rue de l'Artisanat  
34290 - Servian  
Servian • France  
tel. +33 (0) 4 67 39 42 81 • fax: +33 (0) 4 67 39 20 90  
info@indiafrance.eu • www.indiafrance.eu

## GONZATO GROUP CROATIA

Arteferro Gorican d.o.o.  
Gospodarska ulica 1°  
40324 Gorican – Medimurje  
tel. +385 (0) 40 602 222 • fax: +385 (0) 40 602 230  
info@arteferro-dohomont.hr • www.arteferro-dohomont.hr

## GONZATO GROUP ESPAÑA

Ind.i.a. España, SL  
C/ Abedul, 43 – Polig. Ind. El Guijar  
28500 - Arganda del Rey  
Madrid • España  
tel. +34 918 700 819 • fax: +34 918 700 820  
info@arteferro.es • www.arteferro.es

## GONZATO GROUP RUSSIA

ООО "АРТЕФЕРРО-РУССИЯ"  
603124, Россия, Нижний Новгород, Вторчермета 1Г  
Тел. +7-831-2621999  
info@arteferrorussia.com  
www.arteferro.ru

## GONZATO GROUP MEXICO

Arteferro Monterrey SA de CV  
Privada la Puerta 2879 B-4  
66350 - Col. Parque Industrial - La Puerta Santa Catarina  
Nuevo Leon • México  
tel. +52 1 81 1295 5094/95 • fax: +52 1 81 1295 5097  
info@arteferrromexico.com • www.arteferrromexico.com

## GONZATO GROUP ARGENTINA

Arteferro Argentina SA  
Suárez 760  
1162 - Buenos Aires  
Argentina  
tel. +54 11 4301 2637 • fax: +54 11 4301 2637  
info@arteferroargentina.com • www.arteferroargentina.com

## GONZATO GROUP CHILE

Arteferro Chile SA  
Calle Los Arrayanes, 250, bodega 4  
9340000 -Santiago  
Colina • Chile  
tel. +56 2 738 7419 • fax: +56 2 738 7419  
arteferro@arteferrochile.cl • www.arteferrochile.cl

## GONZATO GROUP CHINA

China (Shandong province)  
Representative Far East  
india@arteferro.com

## GONZATO GROUP BRASIL

Ind.i.a. Brasil LTDA  
Rua Padre Feijó, 480  
95190-000 - São Marcos  
Rio Grande do Sul • Brasil  
tel. +55 54 3291 1416 • fax: +55 54 3291 1416  
Branch  
Av. Almirante Cochrane, 194 – Sala 32  
11040-200 – Santos - Sao Paulo • Brasil  
tel. +55 13 21389091  
vendas@arteferrobrasil.com.br  
www.arteferrobrasil.com.br

arteferro.com

Arteferro is a brand of Gonzato Group  
Via Vicenza, 6/14 (SP46) – 36034 Malo (Vicenza) Italy  
Tel. +39 0445 580 580 • Fax +39 0445 580 874  
info@arteferro.com • arteferro.com

